



MARK^{III} Electric Fire Pump Controller - Across The Line Starting

Project Information

VOLTAGE/POWER TABLE	
LINE VOLTAGE	MOTOR HORSEPOWER
208	40-60
220-240	40-60
380-400-415	75-125
440-480	75-150
600	100-150

(DRAWINGS INCLUDED IN THIS PACKAGE ARE FOR STANDARD CONTROLLERS. ACTUAL "AS BUILT" DRAWINGS MAY DIFFER FROM THOSE SEEN HERE).

Firetrol, Inc.

3412 Apex Peakway
Apex, North Carolina 27502
P 919 460 5200
F 919 460 5250
www.firetrol.com

While every precaution has been taken to ensure accuracy and completeness herein, Firetrol, Inc. assumes no responsibility, and disclaims all liability, for damages resulting from use of this information or for any errors or omissions. Specifications and drawings are subject to change without notice. ©2019 Firetrol, Inc., All Rights Reserved.

Firetrol MARK^{III} Electric Fire Pump Controller

FTA1000 – Full Voltage Starting

Specifications

1.0 Main Fire Pump Controller

The main fire pump controller shall be a factory assembled, wired and tested unit. The controller shall be of the combined manual and automatic type designed for full voltage starting of the fire pump motor having the horsepower, voltage, phase and frequency rating shown on the plans and drawings.

1.1 Standards, Listings & Approvals

The controller shall conform to all the requirements of the latest editions of: NFPA 20, *Standard for the Installation of Stationary Pumps for Fire Protection* NFPA 70, *National Electrical Code*.

The controller shall be listed by:

Underwriters Laboratories, Inc., in accordance with UL218, *Standard for Fire Pump Controllers* Canadian Standards Association CSA-C22.2, *Standard for Industrial Control Equipment (cUL)*

CE – Low Voltage Directive

The controller shall be approved by:

Factory Mutual (IEC 62091)

The City of New York for fire pump service

1.2 Enclosure

The controller components shall be housed in a NEMA Type 2 (IEC IP22) drip-proof, wall mounted enclosure with bottom entry gland plate and lifting lugs.

1.3 Withstand Ratings (Short Circuit Current Ratings)

All controller components shall be front mounted, wired and front accessible for maintenance. The available short circuit current ratings are shown below.

Code	200-208V 5-150 HP	220-240V 5-200 HP	380-415V 5-350 HP	440-480 5-400 HP	550-600 5-500 HP
M - Standard	100kA	100kA	100kA	100kA	N/A
N - Intermediate	150kA	150kA	150kA	150kA	N/A
P - High	200kA	200kA	200kA	200kA	N/A
Q - Intermediate	N/A	N/A	N/A	N/A	100kA
R - Standard	N/A	N/A	N/A	N/A	50kA
Code	200-208V 200 HP	220-240V 250-400 HP	380-415V 400-500 HP	440-480 450-500 HP	
M - Standard	50A	50kA	50kA	50kA	
N - Intermediate	N/A	N/A	N/A	N/A	
P - High	100kA	100kA	100kA	100kA	
Q - Intermediate	N/A	N/A	N/A	N/A	
R - Standard	N/A	N/A	N/A	N/A	

1.4 Power Components

The controller shall include a combination isolating disconnect switch/circuit breaker, rated for not less than 115% of the motor full load current, mechanically interlocked and operated with a single, externally mounted handle. The isolating disconnect switch/circuit breaker shall be mechanically interlocked so that the enclosure door cannot be opened with the handle in the ON position except by a hidden tool operated bypass mechanism. The isolating disconnect switch/circuit breaker shall be capable of being padlocked in the OFF position for installation and maintenance safety, and shall also be capable of being locked in the ON position without affecting the tripping characteristics of the circuit breaker.

The controller will include a voltage surge arrester and Across the Line motor starter. The controller shall be equipped with a single handle, manually operated, emergency start mechanism capable of being latched in the ON position.

1.5 Operator Interface (HMI)

The operator interface shall be a 7.0" LCD color touch screen (HMI technology) powered by an embedded microcomputer with software PLC logic. Included shall be keypad type push-buttons for START, STOP and TEST.

The screen shall include menus for: *Home · Alarms · Configuration · History · Service · Manuals · Language.*

The HMI shall graphically display the following: *Voltage and Amperage of all 3 phases simultaneously using true RMS Technology · Motor Stopped/Running · Starting Cause · Actuation Mode · Controller Type · Shutdown Mode · Date & Time · Pump Room Temp. · System Pressure*

System pressure shall be capable of being displayed as: *PSI, kPa, Bar, Feet of Head or Meters of Water.*

The HMI shall allow programming and display of: *Cut In & Cut Out Pressure Settings · Minimum Run Timer · Sequential Start Timer · Periodic Test Timer*

The HMI allows the user to select the language of the system and download the manual or view the manual on screen.

1.6 State and Alarm Indication

Visual indication shall be provided for the following:

Power Available · Motor Run · Periodic Test · Manual Start · Deluge Valve Start · Remote Automatic Start · Remote Manual Start · Emergency Start · Pump On Demand/Automatic Start · Pump Room Temperature · Lockout

The digital display shall visually indicate the following alarms:

• Locked Rotor Current · Fail To Start · Under/Over Current · Under/Over Voltage · Phase Unbalance · Check Test Solenoid Valve · Weekly Test Cut-In Not Reached · Transducer Fault · Control Voltage Not Healthy · Motor Trouble · Pump Room Alarm · Invalid Cut-In · Phase Reversal · Power Loss · Phase Loss L1 / L2 / L3 · Low Water Level · Pump On Demand · Low Ambient Temp. · Service Required

Audible and visible alarm shall be provided for: Fail To Start

Remote Alarm contacts shall be provided for:

Power Available · Phase Reversal · Motor Run · Common Pump Room Alarm (Overvoltage, Undervoltage, Phase Unbalance, Low/High Pump Room Temperature) · Common Motor Trouble (Overcurrent, Fail To Start, Undercurrent, Ground Fault)

1.7 Pressure and Event Recording

The system shall be capable of logging pressure data and operational events with time/date stamp. The system shall display operational events for the lifetime of the controller and display the pressure data in text or graphical form. The controller shall log the Date/Time of the first start-up and the controller total power on time from that date. The controller shall log first and last statistics for: *First Setup · On Time · Start Count · Last Start Time · Min/Max/Average System Pressure · Min/Max/Average Pump Room Temp. · Jockey Pump On Time/Start Count/Last Start Time · Phase to Phase Voltages with Date Stamp · Amps Per Phase with Date Stamp*

1.8 USB Host Controller

A USB port capable of accepting a USB Flash Memory Disk shall be provided for downloading pressure and event logs.

1.9 Serial Communications

The controller shall feature Modbus with TCP/IP frame format and shielded female RJ45 connector

2.0 Pressure Sensing / Wet Parts

The controller shall be supplied with a solid state pressure transducer with a range of 0-500 psi calibrated for 0-300 psi (0-20.7 bar) and a run test solenoid valve. The wet parts shall be externally mounted and include a protective cover. The pressure sensing line connection to the transducer shall be 1/2-inch FNPT. Provisions for a redundant pressure transducer shall be provided.

2.1 Seismic Certification

The controller shall be certified to meet or exceed the requirements of the 2015 International Building Code, the 2016 California Building Code and OSHPD Special Seismic Certification Preapproval - OSP. The controller test criteria shall be per ICC-ES AC156 and the Seismic Parameters per ASCE 7-10 Chapter 13.

2.2 Controller Operation

The controller shall be capable of automatic starting via pressure drop, remote start signal from an automatic device or a deluge valve. The controller can be manually started via the START push-button, the RUN TEST push-button, or a remote signal from a manual device. Stopping can be achieved manually with the STOP push-button or automatically after expiration of minimum run timer or test timer. The minimum run timer (off delay), sequential start timer (on delay) and periodic test timer shall be field adjustable and include a visual countdown on the display.

2.3 Manufacturer

The controller shall be a Firetrol brand.

Firetrol, Inc.

3412 Apex Peakway
Apex, North Carolina 27502
P +1 919 460 5200
F +1 919 460 5250
www.firetrol.com

While every precaution has been taken to ensure accuracy and completeness herein, Firetrol, Inc. assumes no responsibility, and disclaims all liability, for damages resulting from use of this information or for any errors or omissions. Specifications and drawings are subject to change without notice. ©2019 Firetrol, Inc., All Rights Reserved.

Publication SP1000-60

MARK^{III} Electric Fire Pump Controllers – Across The Line Starting



Description – Firetrol® FTA1000 Full Voltage Fire Pump Controllers are intended for use with electric motor driven fire pumps where the capacity of the power source permits full voltage starting. Full voltage is applied to the motor as soon as the controller is actuated. The controller monitors, displays and records fire pump system information.

Full voltage starting is simple and low cost and is preferred whenever the utility or emergency generator set will permit this type of starting.

Approvals – Firetrol fire pump controllers are listed by Underwriters' Laboratories, Inc., in accordance with UL218, *Standard for Fire Pump Controllers*, CSA, *Standard for Industrial Control Equipment*, and approved by Factory Mutual. They are built to meet or exceed the requirements of the approving authorities as well as NEMA and the latest editions of NFPA 20, *Installation of Centrifugal Fire Pumps*, and NFPA 70, *National Electrical Code*.

Standard Features – The following are included as standard with each controller:

- Voltage surge protector
- Main Disconnect Switch sized for connected motor horsepower and voltage
- Fire pump Circuit Breaker
- Single Handle Isolating Disconnect Switch/Circuit Breaker mechanism
- Motor contactor
- Single Handle Emergency Manual Run Mechanism to mechanically close motor contactor contacts in an emergency condition
- Built-in Start and Stop push-buttons to bypass automatic start circuits
- Daylight Savings Time Option
- Elapsed Time Meter

- 7.0" LCD color touch screen (HMI technology) software upgradeable operator interface powered by an embedded microcomputer with software PLC logic.
- 500 PSI Pressure Transducer (calibrated for 300 PSI (20.7 Bar)) and Test Solenoid for fresh water applications, externally mounted with protective cover
- Audible Alarm Bell
- Pump Room Ambient Temperature Switch, Display and Alarms
- Pressure and Event Recording with Date Stamp to System Memory Accessible VIA The User Interface and Downloadable to a USB Flash Drive
- Modbus Communications with TCP/IP frame format and a shielded female RJ45 connector
- NEMA Type 2 (IEC IP22) enclosure
- Suitable for use as Service Equipment
- The controller supplies visual indication of the following: Power Available • Motor Run • Periodic Test • Manual Start • Deluge Valve Start • Remote Automatic Start • Remote Manual Start • Emergency Start • Pump On Demand (Automatic Start) • Low Discharge Pressure • Pump Room Temp. • Lockout
- The controller displays visual indication for the following alarm conditions: Control Voltage Not Healthy • Fail To Start • Invalid Cut-In • Lock Rotor Current • Loss of Power • Low Ambient Temp. • Low Water Level • Motor Trouble • Phase Reversal • Overcurrent • Overvoltage • Phase Loss L1 / L2 / L3 • Phase Unbalanced • Pressure Transducer Fault Detected • Pump On Demand • Pump Room Alarm • Service Required • Undercurrent • Undervoltage • Check Test Solenoid • Weekly Test Cut-In Reached
- Audible and Visible Indication for Fail To Start.
- DPDT 8A, 250VAC remote alarm contacts are provided for: Power Available • Phase Reversal • Motor Run
 - Common Pump Room Alarm (Overvoltage / Undervoltage / Phase Unbalance / Low Pump Room Temp. / High Pump Room Temp)
 - Common Motor Trouble (Overcurrent / Fail To Start / Undercurrent / Ground Fault)
- Field Adjustable Timers with Visual Countdown for Minimum Run (Off Delay), Sequential Start (On Delay) and Weekly Test
- Seismic Certification per IBC 2015, CBC 2016 (Consult Factory for Verification)

Product Description – Options & Modifications

SPECIAL ENCLOSURES

- E Enclosure, NEMA Type 4 (IP66), Painted Steel
- F Enclosure, NEMA Type 4X (IP66), #304 Stainless Steel, Brushed Finish
- FD Enclosure, NEMA Type 4X (IP66), #316 Stainless Steel, Brushed Finish
- FDB Enclosure, NEMA Type 4X (IP66), #316 Stainless Steel, 12 Gauge, Seam-Welded, Brushed Finish
- FDP Enclosure, NEMA Type 4X (IP66), #316 Stainless Steel, Painted Finish
- FXP Enclosure, NEMA Type 4X (IP66), #304 Stainless Steel, Painted Finish
- G Enclosure, NEMA Type 12 (IP54), Painted Steel
- T Enclosure, NEMA Type 3R (IP24), Painted Steel
- U Enclosure, NEMA Type 3 (IP54), Painted Steel

CIRCUIT BREAKER OPTION

- N Intermediate withstand rating - 150,000 Amps RMS Sym. (200-480V) - 100,000 Amps RMS Sym. (550-600V)
- P High withstand rating 200,000 Amps RMS Sym (200-480V)

Note: Intermediate and High withstand ratings may not be available for all horsepower and voltages. Consult factory for availability.

ANTI-CONDENSATION SPACE HEATERS

- J Space Heater, 120V Externally Powered with Circuit Breaker and Thermostat
- K Space Heater, 120V Externally Powered with Circuit Breaker and Humidistat
- M Space Heater, 240V Externally Powered with Circuit Breaker and Thermostat
- N Space Heater, 240V Externally Powered with Circuit Breaker and Humidistat
- JKP Space Heater, 120V Externally Powered with Circuit Breaker and Thermostat and Humidistat in Parallel
- MNP Space Heater, 240V Externally Powered with Circuit Breaker and Thermostat and Humidistat in Parallel

Pressure Transducers, Solenoid Valves, Plumbing

- D1 Wetted Parts Including Pressure Sensor and Test Solenoid, 500 PSI (34.5 Bar), Sea Water
- SX1 Low Suction Pressure Transducer, Fresh Water, 0-300 PSI (20.4 Bar) with Visible Indication and Output Contacts
- SX2 Low Suction Pressure Transducer, Sea Water, 0-300 PSI (20.4 Bar) with Visible Indication and Output Contacts

COMBINED AUTOMATIC POWER TRANSFER SWITCHES

- TSA FTA950 Automatic Transfer Switch (See Pub. PD1000-61)
- TSAB FTA951 Automatic Transfer Switch, J-Bypass Isolation

ALARMS

- AC Alarm Output Contacts Extra, Pump Operating (1 Form A, 1 Form B)
- AM Alarm Output Contacts, Fail to Start
- AV Alarm Output Contacts, Low Pump Room Temperature (Requires option -AF)
- AW Alarm Output Contacts, Reservoir Low (Requires option -AG)
- AY1 Configurable Low Suction Pressure, Visible/Output Contacts with external digital input
- BW1 Extra Alarm Output Contacts, Phase Failure/Phase Reversal

- BY1 Alarm Output Contacts, Overcurrent
- CTS1 Configurable Low Suction Pressure, Visible/Output Contacts with Suction Pressure Transducer
- EHI Alarm, Visible/Output Contacts, Main Relief Valve Open
- EK Alarm Visible/Output Contacts, Flow Meter Open
- JR Visible Indicator, Jockey Pump Operating
- JT Alarm, Audible/Visible, Jockey Pump Trouble
- KIH Alarm Output Contacts, Common Alarm
- LY Alarm Output Contacts, Pump On Demand
- P Alarm, Audible/Visible, Built-In 120V Supervisory System (Includes visible supervisory voltage normal indication and audible pump operating, phase failure and phase reversal indication)
- PT Alarm, Audible/Visible, Built-in 240V Supervisory System (Includes visible supervisory voltage normal indication and audible pump operating, phase failure and phase reversal indication)

MISCELLANEOUS

- EL Series Pumping Operation, High Zone Controller
- EM Series Pumping Operation, Mid Zone Controller
- EN Series Pumping Operation, Low Zone Controller
- IEC Marking, CE with External Wet Parts
- MZN Neutral Lug, Service Entrance, Non-insulated Bonded to Enclosure
- PK Terminal Blocks, Extra Remote Start
- PY Output Contacts, Motor Space Heater Circuit, Externally Powered
- S Tropicalization
- USBX Data Port, External USB
- ZPMI Data Port, RS485 Modbus RTU

Export packaging (Wooden crating to conform to IPPC Standards)
FTA1000 - 1930

Firetrol, Inc.

3412 Apex Peakway
Apex, North Carolina 27502
P +1 919 460 5200
F +1 919 460 5250
www.firetrol.com

While every precaution has been taken to ensure accuracy and completeness herein, Firetrol, Inc. assumes no responsibility, and disclaims all liability, for damages resulting from use of this information or for any errors or omissions. Specifications and drawings are subject to change without notice. ©2019 Firetrol, Inc., All Rights Reserved.

Model Number Selection Guide



FTA1000 – FTA1930

MARK^{III} Electric Fire Pump Controllers

FTA1000, 1250, 1300, 1350, 1800, 1930 ELECTRIC FIRE PUMP CONTROLLERS Example: FTA1300-AM75HH-xx

Starting Method
 1000 - Across-the-line (direct on line)
 1250 - Part Winding (50%-50% windings)
 1300 - Wye-delta (star-delta), open transition
 1350 - Wye-delta (star-delta), closed transition
 1800 - Autotransformer
 1930 - Digital Solid-state soft start/stop

Start/Stop Options
 A - Automatic start with timed permissive stop after minimum run time and manual start with manual stop, field convertible to automatic start and manual start with manual stop only
 B - Automatic start and manual start with manual stop
 C - Manual start and stop

Short Circuit Current Rating

Code	200-208V 5-150 HP	220-240V 5-200 HP	380-415V 5-350 HP	440-480V 5-400 HP	550-600V 5-500 HP
M - Standard	100kA	100kA	100kA	100kA	N/A
N - Intermediate	150kA	150kA	150kA	150kA	N/A
P - High	200kA	200kA	200kA	200kA	N/A
Q - Intermediate	N/A	N/A	N/A	N/A	100kA
R - Standard	N/A	N/A	N/A	N/A	50kA

Code	200-208V 200 HP	220-240V 250-400 HP	380-415V 400-500 HP	440-480V 450-500 HP
M - Standard	50A	50kA	50kA	50kA
N - Intermediate	N/A	N/A	N/A	N/A
P - High	100kA	100kA	100kA	100kA
Q - Intermediate	N/A	N/A	N/A	N/A
R - Standard	N/A	N/A	N/A	N/A

Modifications
See Back

Three Phase Voltage
 A - 220-240 Volt, 60 Hertz (230 V)
 AZ - 220-230 Volt, 50 Hertz
 B - 440-480 Volt, 60 Hertz (460 V)
 BZ - 415 Volt, 50 Hertz
 C - 550-600 Volt, 60 Hertz (575 V)
 F - 380 Volt, 60 Hertz
 FZ - 380 Volt, 50 Hertz
 FF - 400 Volt, 60 Hertz
 FX - 400 Volt, 50 Hertz
 H - 208 Volt, 60 Hertz
 HH - 200 Volt, 60 Hertz

Horsepower Rating

03 - 3 HP	100 - 100 HP
05 - 5 HP	125 - 125 HP
07 - 7 1/2 HP	150 - 150 HP
10 - 10 HP	200 - 200 HP
15 - 15 HP	250 - 250 HP
20 - 20 HP	300 - 300 HP
25 - 25 HP	350 - 350 HP
30 - 30 HP	400 - 400 HP
40 - 40 HP	450 - 450 HP
50 - 50 HP	500 - 500 HP
60 - 60 HP	
75 - 75 HP	

Model Number Selection Guide - Options & Modifications

SPECIAL ENCLOSURES

- E Enclosure, NEMA Type 4 (IP66), Painted Steel
- F Enclosure, NEMA Type 4X (IP66), #304 Stainless Steel, Brushed Finish
- FD Enclosure, NEMA Type 4X (IP66), #316 Stainless Steel, Brushed Finish
- FDB Enclosure, NEMA Type 4X (IP66), #316 Stainless Steel, 12 Gauge, Seam-Welded, Brushed Finish
- FDP Enclosure, NEMA Type 4X (IP66), #316 Stainless Steel, Painted Finish
- FXP Enclosure, NEMA Type 4X (IP66), #304 Stainless Steel, Painted Finish
- G Enclosure, NEMA Type 12 (IP54), Painted Steel
- T Enclosure, NEMA Type 3R (IP24), Painted Steel
- U Enclosure, NEMA Type 3 (IP54), Painted Steel

CIRCUIT BREAKER OPTION

- N Intermediate withstand rating - 150,000 Amps RMS Sym. (200-480V) - 100,000 Amps RMS Sym. (550-600V)
- P High withstand rating 200,000 Amps RMS Sym (200-480V)

Note: Intermediate and High withstand ratings may not be available for all horsepower and voltages. Consult factory for availability.

ANTI-CONDENSATION SPACE HEATERS

- J Space Heater, 120V Externally Powered with Circuit Breaker and Thermostat
- K Space Heater, 120V Externally Powered with Circuit Breaker and Humidistat
- M Space Heater, 240V Externally Powered with Circuit Breaker and Thermostat
- N Space Heater, 240V Externally Powered with Circuit Breaker and Humidistat
- JKP Space Heater, 120V Externally Powered with Circuit Breaker and Thermostat and Humidistat in Parallel
- MNP Space Heater, 240V Externally Powered with Circuit Breaker and Thermostat and Humidistat in Parallel

Pressure Transducers, Solenoid Valves, Plumbing

- D1 Wetted Parts Including Pressure Sensor and Test Solenoid, 500 PSI (34.5 Bar), Sea Water
- SX1 Low Suction Pressure Transducer, Fresh Water, 0-300 PSI (20.4 Bar) with Visible Indication and Output Contacts
- SX2 Low Suction Pressure Transducer, Sea Water, 0-300 PSI (20.4 Bar) with Visible Indication and Output Contacts

COMBINED AUTOMATIC POWER TRANSFER SWITCHES

- TSA FTA950 Automatic Transfer Switch (See Pub. PDI000-61)
- TSAB FTA951 Automatic Transfer Switch, J-Bypass Isolation

ALARMS

- AC Alarm Output Contacts Extra, Pump Operating (1 Form A, 1 Form B)
- AM Alarm Output Contacts, Fail to Start
- AV Alarm Output Contacts, Low Pump Room Temperature (Requires option -AF)
- AW Alarm Output Contacts, Reservoir Low (Requires option -AG)
- AY1 Configurable Low Suction Pressure, Visible/Output Contacts with external digital input
- BW1 Extra Alarm Output Contacts, Phase Failure/Phase

Reversal

- BY1 Alarm Output Contacts, Overcurrent
- CTSI Configurable Low Suction Pressure, Visible/Output Contacts with Suction Pressure Transducer
- EH1 Alarm, Visible/Output Contacts, Main Relief Valve Open
- EK1 Alarm Visible/Output Contacts, Flow Meter Open
- JR Visible Indicator, Jockey Pump Operating
- JT Alarm, Audible/Visible, Jockey Pump Trouble
- KH Alarm Output Contacts, Common Alarm
- LY Alarm Output Contacts, Pump On Demand
- P Alarm, Audible/Visible, Built-In 120V Supervisory System (Includes visible supervisory voltage normal indication and audible pump operating, phase failure and phase reversal indication)
- PT Alarm, Audible/Visible, Built-in 240V Supervisory System (Includes visible supervisory voltage normal indication and audible pump operating, phase failure and phase reversal indication)

MISCELLANEOUS

- EL Series Pumping Operation, High Zone Controller
- EM Series Pumping Operation, Mid Zone Controller
- EN Series Pumping Operation, Low Zone Controller
- IEC Marking, CE with External Wet Parts
- MZN Neutral Lug, Service Entrance, Non-insulated Bonded to Enclosure
- PK Terminal Blocks, Extra Remote Start
- PY Output Contacts, Motor Space Heater Circuit, Externally Powered
- S Tropicalization
- USBX Data Port, External USB
- ZPM1 Data Port, RS485 Modbus RTU

Export packaging (Wooden crating to conform to IPPC Standards)
FTA1000 - 1930

Firetrol, Inc.

3412 Apex Peakway
Apex, North Carolina 27502
P +1 919 460 5200
F +1 919 460 5250
www.firetrol.com

While every precaution has been taken to ensure accuracy and completeness herein, Firetrol, Inc. assumes no responsibility, and disclaims all liability, for damages resulting from use of this information or for any errors or omissions. Specifications and drawings are subject to change without notice. ©2019 Firetrol, Inc., All Rights Reserved.

General Starting Configuration

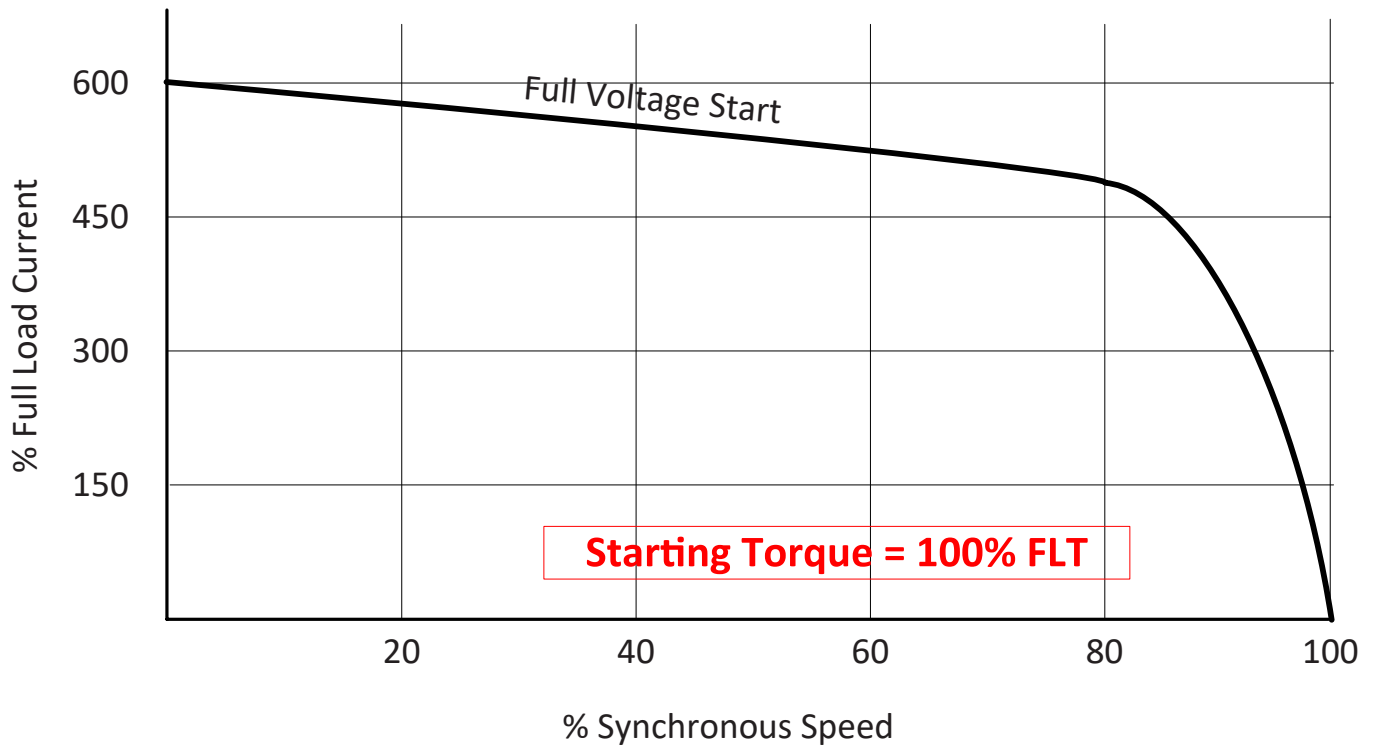

Firetrol, Inc.

3412 Apex Peakway
Apex, North Carolina 27502
P +1 919 460 5200
F +1 919 460 5250
www.firetrol.com

While every precaution has been taken to ensure accuracy and completeness herein, Firetrol, Inc. assumes no responsibility, and disclaims all liability, for damages resulting from use of this information or for any errors or omissions. Specifications and drawings are subject to change without notice. ©2019 Firetrol, Inc., All Rights Reserved.

Dimensions and Shipping Weight



FTA1000

MARK^{III} Electric Fire Pump Controllers - Across The Line Starting

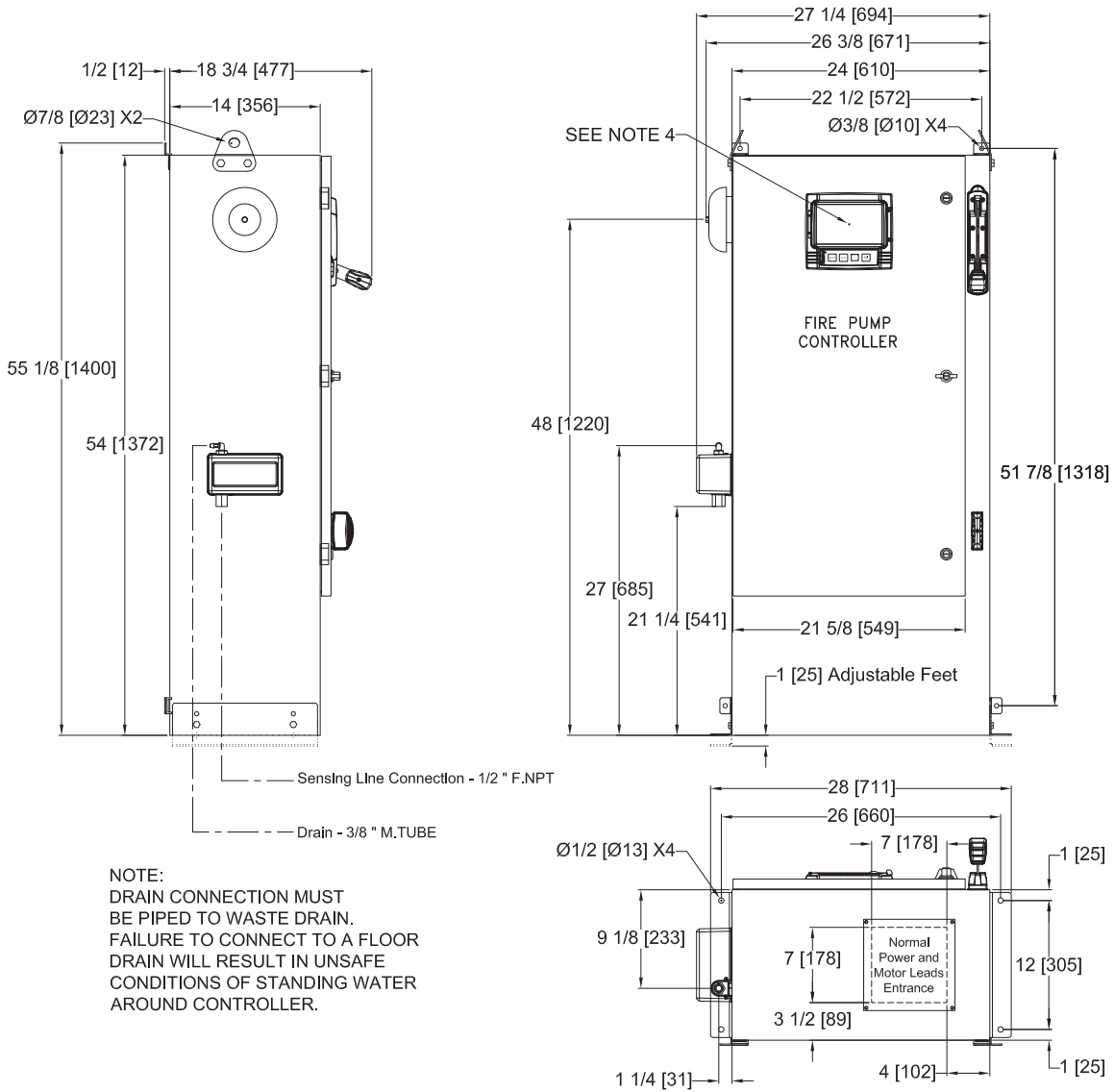

NOTE:
DRAIN CONNECTION MUST BE PIPED TO WASTE DRAIN. FAILURE TO CONNECT TO A FLOOR DRAIN WILL RESULT IN UNSAFE CONDITIONS OF STANDING WATER AROUND CONTROLLER.

NOTES:

1. STANDARD: NEMA 2
2. STANDARD PAINT: TEXTURED RED RAL3002
3. ALL DIMENSIONS IN INCHES [MILLIMETERS] SHIPPING WEIGHT IN POUNDS [KG]
4. CENTER OF MARK III SCREEN: 47 5/8 [1208] FROM BOTTOM OF ENCLOSURE
5. BOTTOM CONDUIT ENTRANCE THROUGH REMOVABLE GLAND PLATE RECOMMENDED
6. USE WATERTIGHT CONDUIT AND CONNECTOR ONLY
7. PROTECT EQUIPMENT AGAINST DRILLING CHIPS
8. DOOR SWING EQUAL TO DOOR WIDTH
9. DRAWINGS FOR CONSTRUCTION PURPOSES MUST BE OBTAINED FROM FIRETROL OR THE LOCAL FIRETROL REPRESENTATIVE
10. SEISMIC MOUNTING TO BE RIGID WALL AND BASE ONLY

VOLTAGE/POWER TABLE	
LINE VOLTAGE	MOTOR HORSEPOWER
208	40-60
220-240	40-60
380-400-415	75-125
440-480	75-150
600	100-150
APPROX SHIPPING WT: 225 [102]	

	SIZE	A	BY	CJR	DATE	11-5-19	<p>© Firetrol, Inc. Not for construction. Subject to change without notice.</p>	RELEASED	-	-	CJR	CJR	11-5-19
	DRAWN BY	CJR	11-5-19	REVISION DESCRIPTION	REV	ECN NO		BY	APP	DATE			
	FULL VOLTAGE FIRE PUMP CONTROLLER	FTA1000		DRAWING NUMBER		DD1000-71		CDL					
	DWG REV	-	ECN NO	-	SHEET 1 OF 1								

All rights reserved. The drawing and the information contained or depicted herein are the sole property of Firetrol, Inc. Copies are communicated to the recipient in strict confidence and may not be retransmitted, published, reproduced, copied or used in any manner, including as the basis for the manufacture or sale of any products, without the express prior written consent of Firetrol, Inc.

MARK^{III} Electric Fire Pump Controllers - Across The Line Starting

Control Terminals (EB1)

Terminals Wire Size:
24 - 12 AWG
0.5 Nm

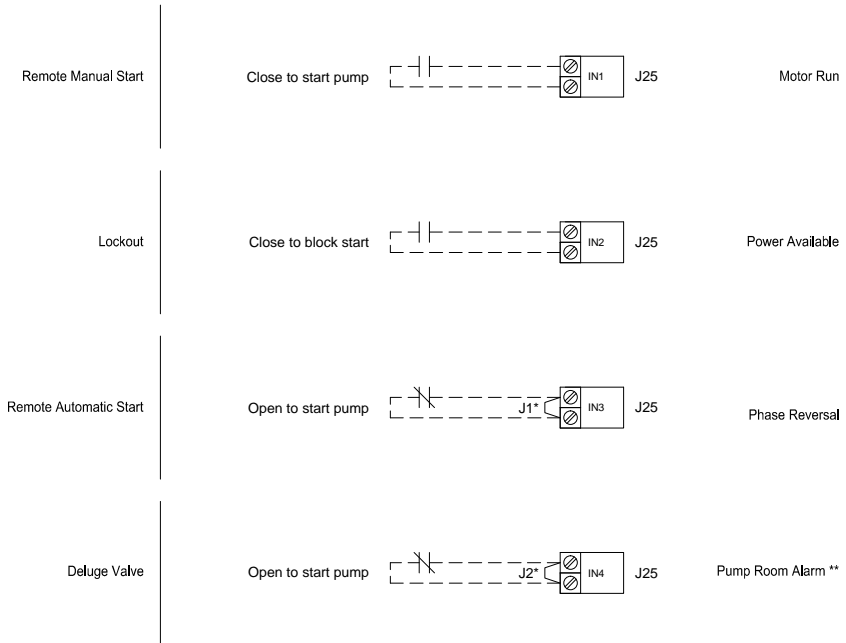

Alarm Inputs (EB1)

Terminals Wire Size:
24 - 12 AWG
0.5 Nm

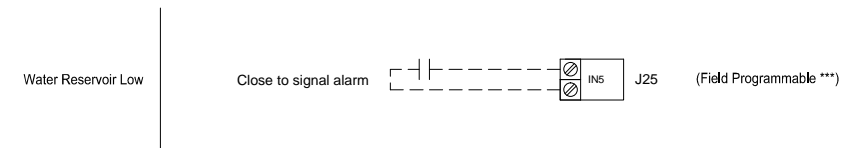

Remote Alarm Terminals (EB1)

Terminals Wire Size:
24 - 12 AWG
0.5 Nm

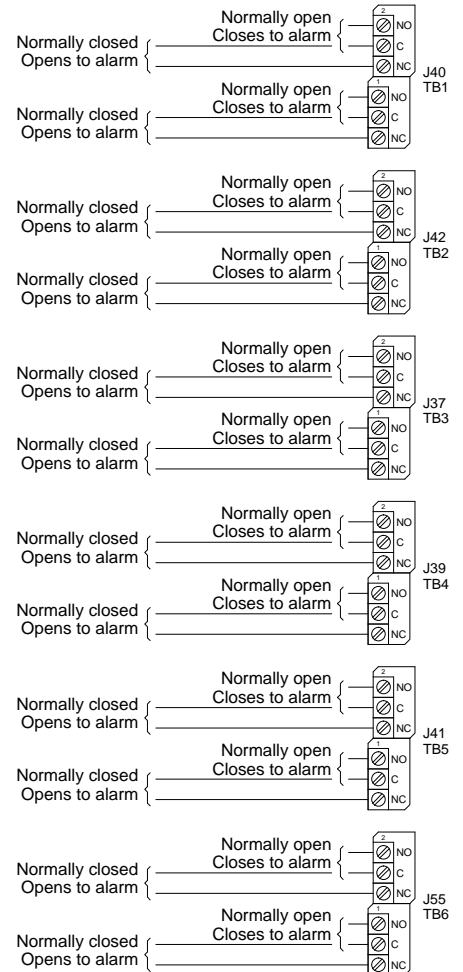

Network Connection (VMB1)

Shielded Female Connector RJ45

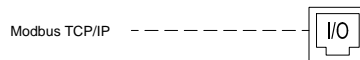

* Remove jumper to use this feature
** Re-assignable
*** Not available on FTA1930 models

Drawing for information only.
Manufacturer reserves the right to modify this drawing without notice.
Contact manufacturer for "As Built" drawing.

	SIZE	A	BY	DATE	<p>© Firetrol, Inc. Not for construction. Subject to change without notice.</p>	RELEASED	-	-	CIR	CIR	11-11-19
	DRAWN BY	CIR	11-10-19	REVISION DESCRIPTION		REV	ECN NO	BY	APP	DATE	
	FINAL APPROVAL	CIR	11-10-19	FIELD CONNECTIONS		FTA1000	DRAWING NUMBER		FC1000-60		CDL
	FULL VOLTAGE FIRE PUMP CONTROLLER					DWG REV	-	ECN NO	-	SHEET 1 OF 1	

MARK^{III} Electric Fire Pump Controllers - Across The Line Starting

Line Terminals

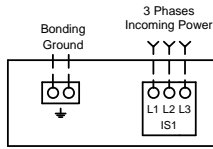

Notes:

- 1 - For proper wire sizing, refer to NFPA70 and NEC (USA) or CEC (Canada) or local code.
- 2 - Controller suitable for service entrance in USA.
- 3 - For more accurate motor connections refer to motor manufacturer or motor nameplate.
- 4 - Controller is phase sensitive. Incoming lines must be connected in ABC sequence.

COPPER CONDUCTORS for Isolating Switch (IS1).

Field Wiring According to Bending Space (AWG or MCM). Terminals L1 - L2 - L3

Bending Space	5" (127 mm)							8" (203 mm)			
	HP	5	7.5	10	15	20	25	30	40	50	60
208	1x (10 to 1/0)	1x (8 to 1/0)	1x (8 to 1/0)	1x (6 to 1/0)	1x (4 to 1/0)	1x (3 to 1/0)	1x (2 to 1/0)	1x (1 to 250)	1x (3/0 to 250)	1x (4/0 to 250)	
220 to 240	1x (10 to 1/0)	1x (10 to 1/0)	1x (8 to 1/0)	1x (6 to 1/0)	1x (4 to 1/0)	1x (3 to 1/0)	1x (2 to 1/0)	1x (1 to 250)	1x (2/0 to 250)	1x (3/0 to 250)	
380 to 416	1x (10 to 1/0)	1x (10 to 1/0)	1x (10 to 1/0)	1x (8 to 1/0)	1x (6 to 1/0)	1x (6 to 1/0)	1x (6 to 1/0)	1x (4 to 1/0)	1x (3 to 1/0)	1x (3 to 1/0)	
440 to 480	1x (10 to 1/0)	1x (10 to 1/0)	1x (10 to 1/0)	1x (10 to 1/0)	1x (8 to 1/0)	1x (8 to 1/0)	1x (6 to 1/0)	1x (6 to 1/0)	1x (4 to 1/0)	1x (3 to 1/0)	
600	1x (10 to 1/0)	1x (10 to 1/0)	1x (10 to 1/0)	1x (10 to 1/0)	1x (10 to 1/0)	1x (8 to 1/0)	1x (8 to 1/0)	1x (6 to 1/0)	1x (6 to 1/0)	1x (4 to 1/0)	

Bending Space	12" (305 mm)				16" (406 mm)							
	HP	75	100	125	150	200	250	300	350	400	450	500
208	1x (300 to 500)	1x (500)	2x (4/0 to 500)	2x (250 to 500)	2x (400 to 600)	-----	-----	-----	-----	-----	-----	-----
220 to 240	1x (250 to 500)	1x (350 to 500)	2x (3/0 to 500)	2x (4/0 to 500)	2x (350 to 500)	2x (500 to 600)	-----	-----	-----	-----	-----	-----
380 to 416	1x (1/0 to 250)	1x (3/0 to 250)	1x (250)	1x (300 to 500)	2x (3/0 to 250)	2x (4/0 to 500)	2x (300 to 500)	2x (400 to 600)	2x (500 to 600)	2x (600)	-----	-----
440 to 480	1x (1 to 250)	1x (2/0 to 250)	1x (3/0 to 250)	1x (4/0 to 250)	1x (350 to 500)	2x (3/0 to 250)	2x (4/0 to 500)	2x (300 to 500)	2x (350 to 500)	2x (400 to 600)	2x (500 to 600)	-----
600	1x (3 to 1/0)	1x (1 to 250)	1x (2/0 to 250)	1x (3/0 to 250)	1x (250 to 500)	1x (350 to 500)	2x (3/0 to 250)	2x (4/0 to 500)	2x (250 to 500)	2x (300 to 500)	2x (350 to 500)	-----

Bending Space	5" (127 mm)	8" (203 mm)	12" (305 mm)
---------------	-------------	-------------	--------------

Motor Terminals

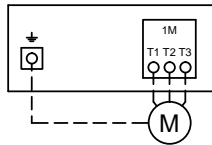

COPPER CONDUCTORS for Motor Connection (1M).

Field Wiring According to Bending Space (AWG or MCM). Terminals T1 - T2 - T3

HP	5	7.5	10	15	20	25	30	40	50	60
	208	1x (10)	1x (10)	1x (8 to 2)	1x (6 to 2)	1x (4 to 1/0)	1x (3 to 1/0)	1x (2 to 1/0)	1x (1/0 to 3/0)	1x (3/0)
220 to 240	1x (12 to 10)	1x (10)	1x (8 to 2)	1x (6 to 2)	1x (4 to 1/0)	1x (4 to 1/0)	1x (3 to 1/0)	1x (1 to 3/0)	1x (2/0 to 3/0)	1x (3/0)
380 to 416	1x (14 to 10)	1x (12 to 10)	1x (10)	1x (8 to 2)	1x (8 to 2)	1x (6 to 2)	1x (6 to 1/0)	1x (4 to 1/0)	1x (3 to 1/0)	1x (3 to 1/0)
440 to 480	1x (14 to 10)	1x (14 to 10)	1x (12 to 10)	1x (10)	1x (8 to 2)	1x (8 to 2)	1x (6 to 2)	1x (6 to 2)	1x (4 to 1/0)	1x (3 to 1/0)
600	1x (14 to 10)	1x (14 to 10)	1x (14 to 10)	1x (10)	1x (10)	1x (8 to 2)	1x (8 to 2)	1x (6 to 2)	1x (6 to 2)	1x (4 to 1/0)

HP	75	100	125	150	200	250	300	350	400	450	500
	208	1x (300)	2x (2/0 to 300)	2x (4/0 to 300)	2x (250 to 300)	2x (400 to 600)	-----	-----	-----	-----	-----
220 to 240	1x (250 to 300)	2x (2/0 to 300)	2x (3/0 to 300)	2x (4/0 to 300)	2x (350 to 500)	2x (500 to 600)	-----	-----	-----	-----	-----
380 to 416	1x (1/0 to 3/0)	1x (3/0)	1x (250 to 300)	1x (300)	2x (3/0 to 300)	2x (4/0 to 300)	2x (300)	2x (400 to 500)	2x (500 to 600)	2x (600)	-----
440 to 480	1x (1 to 1/0)	1x (2/0 to 3/0)	1x (3/0)	1x (4/0 to 300)	2x (1/0 to 300)	2x (3/0 to 300)	2x (4/0 to 300)	2x (300)	2x (350 to 500)	2x (400 to 600)	2x (500 to 600)
600	1x (3 to 1/0)	1x (1 to 1/0)	1x (2/0 to 3/0)	1x (3/0)	1x (250 to 300)	2x (2/0 to 300)	2x (3/0 to 300)	2x (4/0 to 300)	2x (250 to 300)	2x (300)	2x (350 to 500)

THIRD ANGLE PROJECTION	SIZE	A	BY	DATE
	DRAWN BY	CIR	11-10-19	
	FINAL APPROVAL	CIR	11-10-19	

Firetrol, Inc.
© Firetrol, Inc. Not for construction. Subject to change without notice.

RELEASED	-	-	CIR	CIR	11-11-19
REVISION DESCRIPTION	REV	ECN NO	BY	APP	DATE
FIELD CONNECTIONS		FTA1000			
FULL VOLTAGE FIRE PUMP CONTROLLER LINE AND MOTOR FIELD WIRE TERMINAL CAPACITY	DRAWING NUMBER FC1000-61		CDL		
	DWG REV	ECN NO	SHEET 1 OF 1		

All rights reserved. The drawing and the information contained or depicted herein are the sole property of Firetrol, Inc. Copies are communicated to the recipient in strict confidence and may not be retransmitted, published, reproduced, copied or used in any manner, including as the basis for the manufacture or sale of any products, without the express prior written consent of Firetrol, Inc.

MARK^{III} Electric Fire Pump Controllers - Across The Line Starting

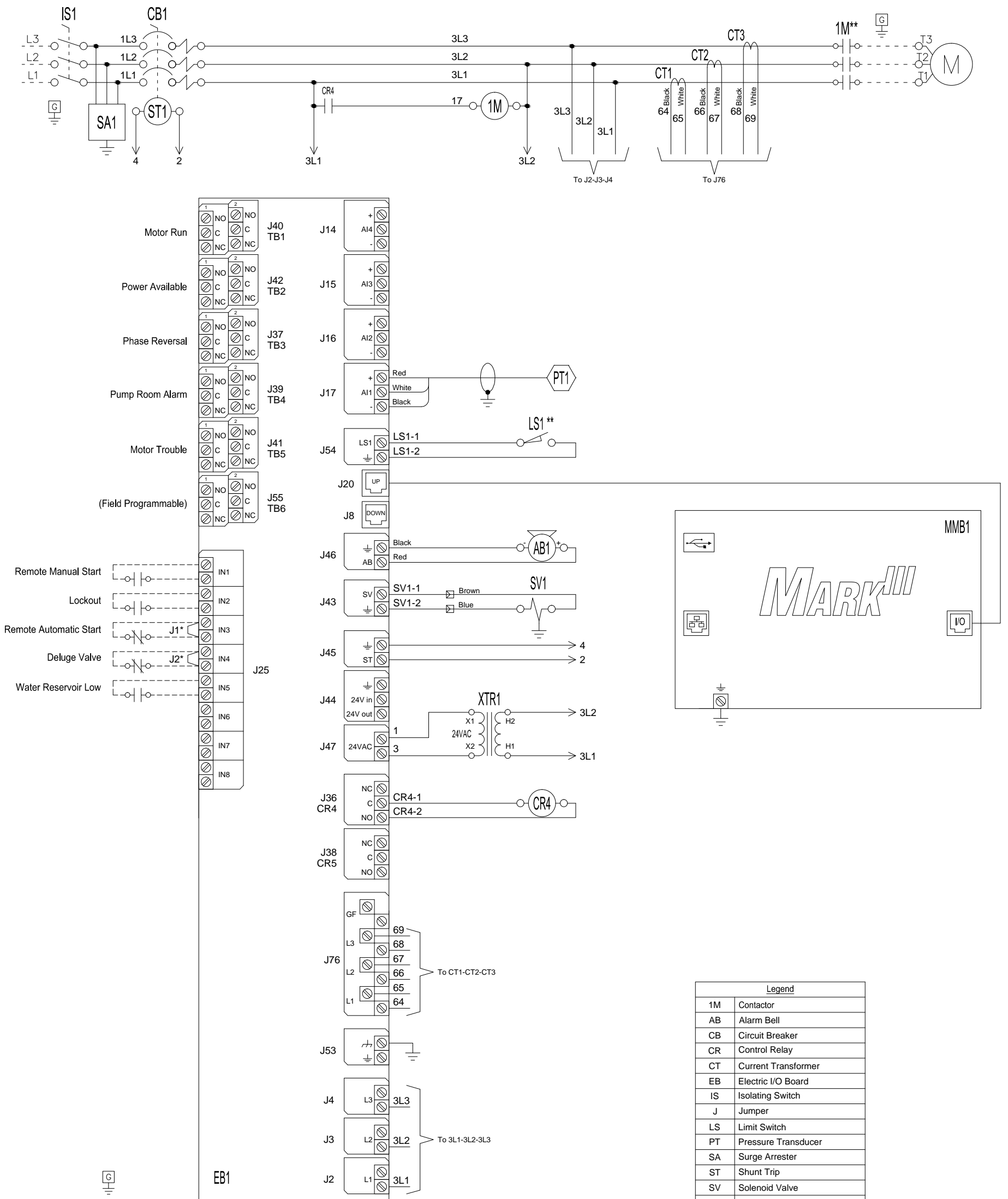

Legend	
1M	Contactors
AB	Alarm Bell
CB	Circuit Breaker
CR	Control Relay
CT	Current Transformer
EB	Electric I/O Board
IS	Isolating Switch
J	Jumper
LS	Limit Switch
PT	Pressure Transducer
SA	Surge Arrester
ST	Shunt Trip
SV	Solenoid Valve
MMB	Mark III Main Board
XTR	Transformer

* Remove jumper to use this feature
 ** Contact closes when emergency start is in "ON" position

Drawing for information only.
 Manufacturer reserves the right to modify this drawing without notice.
 Contact manufacturer for "As Built" drawing.

SIZE	B	BY	DATE	REVISION DESCRIPTION	REV	ECN NO	BY	APP	DATE
THIRD ANGLE PROJECTION		CIR	12/2/19	WIRING SCHEMATIC		FTA1000			
FINAL APPROVAL		CIR	12/2/19	FULL VOLTAGE FIRE PUMP CONTROLLER					
					DRAWING NUMBER		WS1000-70		
					DWC		SHEET 1 OF 1		

All rights reserved. The drawing and the information contained or depicted herein are the sole property of Firetrol, Inc. Copies are communicated to the recipient in strict confidence and may not be retransmitted, published, reproduced, copied or used in any manner, including as the basis for the manufacture or sale of any products, without the express prior written consent of Firetrol, Inc.