

 **PENTAIR**
AURORA

3800 SERIES

SINGLE STAGE END SUCTION PUMPS



Certified to
NSF/ANSI 372

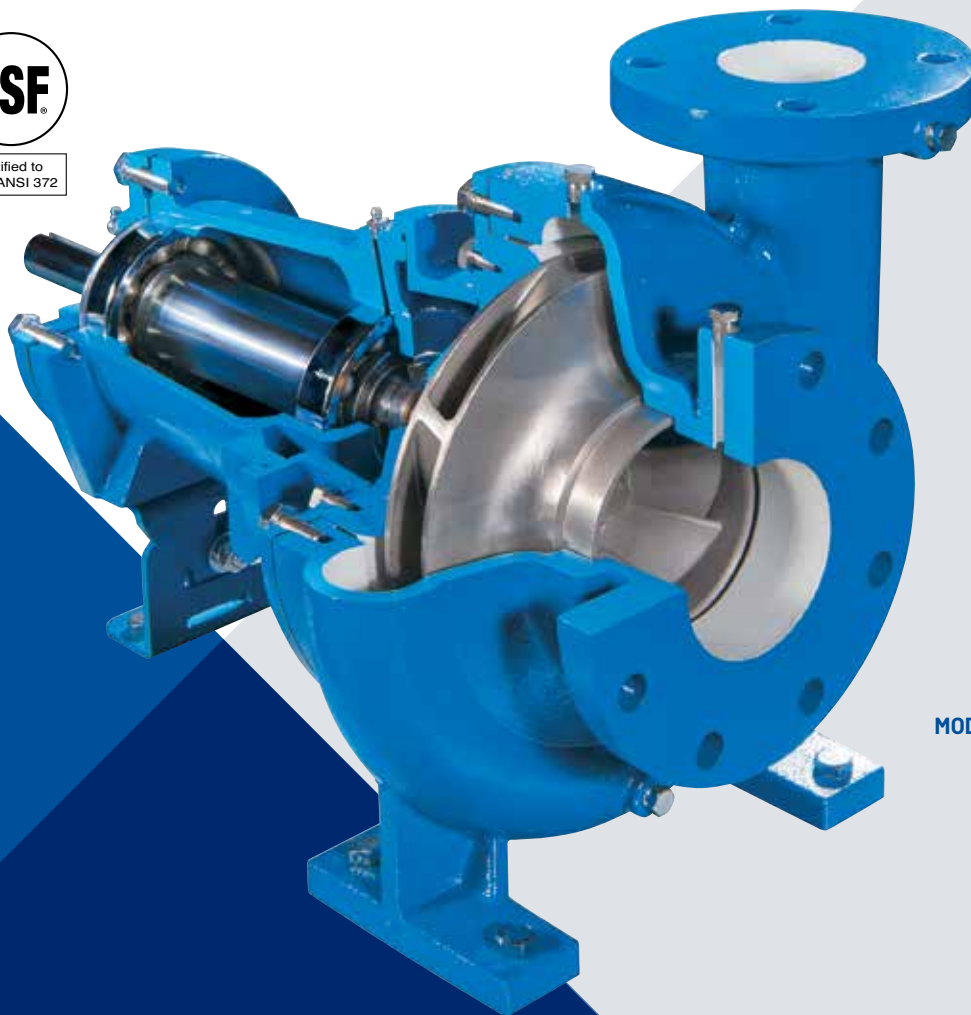

MODEL 3804

AURORA® 3800 SERIES

Single Stage End Suction Pumps

Capacities to 4200 gpm (954 m³/hr)
Heads to 520 feet (158 meters)
Temperatures to 300°F (149°C)

Setting New Standards of Efficiency

Liquid handling requirements are much more involved than they were years ago. The variety of liquids being handled has increased along with temperatures and pressures. Today's installations demand quiet, smooth running pumps with long life. Aurora's 90 years of experience with design, sales and manufacturing of centrifugal pumps has led to the 3800 Series. These modern pumps with a clean, straightforward design were developed with maximum interchangeability in mind. Aurora's highly reliable 3800 pumps offer an economical solution to your liquid handling problems.



Standard Features

- Offered in two models:
 - 3801 Close coupled
 - 3804 Flexible coupled-frame mounted
- 316 SST impeller
- 316 SST shaft sleeve
- Double volute on 4" discharge and larger to reduce bearing loads
- Gauge taps on suction and discharge on flanged models
- 4 Power frame sizes
- Casing feet for easy back pullout
- Regreaseable bearings (3804 only)
- Coupling guard (flex coupled design)
- Formed steel base (flex coupled design)

Optional Features

- 316 SST shaft
- Drip rim base
- Drip pan (3804 only)
- Flush lines
- Epoxy coating
- Several mechanical seal options (required for temperatures over 225°F)
- Oil lube bearings (flex coupled only)
- Case wear ring

Model 3801 Product Offering

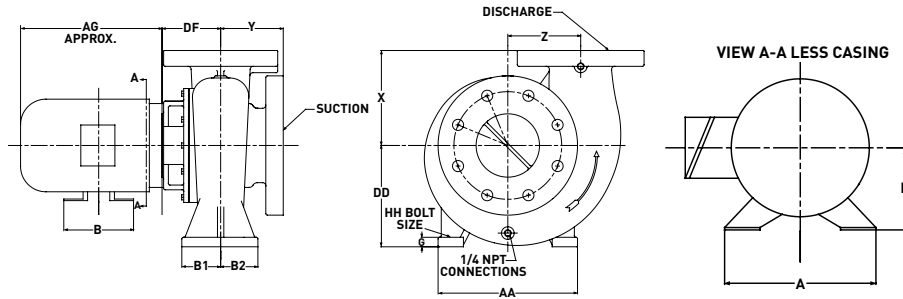

Notes:

1. Dimensions are approximate.
2. All dimensions are in inches (mm) and may vary $\pm 1/4$ (6).
3. Not for construction purposes unless certified.
 - ▲ Available in 250 lb./125 lb. flanges.
 - Dimensions do not match Bell & Gossett.
4. Conduit box is shown in approximate location. Dimensions are not specified as they may vary with each motor manufacturer.
5. There are two mounting holes on the rear foot for the noted pumps.

Pump Size	Disch.	Suct.	DD	X	Y	Z	B1	B2	G	HH	AA	DF 143-184JM	DF 213-215JM	DF 254-256JM	DF 284-326JM	DF 364-404TCZ	DF 444-449TCZ
1.25x1.5x7 (NPT)	1.25	1.5	7.00 (178)	5.00 (127)	3.25 (83)	4.50 (114)	2.63 (67)	2.38 (60)	0.63 (16)	0.44 (11)	8.00 (203)	4.25 (108)	4.25 (108)	N/A	N/A	N/A	N/A
1.5x2x7 (NPT)	1.5	2	7.00 (178)	6.00 (152)	3.13 (79)	4.63 (117)	2.44 (62)	2.56 (65)	0.63 (16)	0.44 (11)	8.00 (203)	4.75 (121)	4.75 (121)	5.31 (135)	N/A	N/A	N/A
1.5x2x11 (NPT)	1.5	2	8.00 (203)	9.00 (229)	3.13 (79)	5.75 (146)	2.25 (57)	3.75 (95)	0.69 (17)	0.44 (11)	11.00 (279)	4.63 (118)	4.63 (118)	5.63 (143)	5.63 (143)	N/A	N/A
1.5x2x12 (NPT)	1.5	2	10.00 (254)	10.00 (254)	2.75 (70)	5.75 (146)	2.87 (73)	3.75 (95)	0.69 (17)	0.44 (11)	11.00 (279)	4.81 (122)	4.81 (122)	N/A	N/A	N/A	N/A
2x2.5x7▲	2	2.5	7.00 (178)	6.50 (165)	3.50 (89)	4.75 (121)	2.56 (65)	2.44 (62)	0.63 (16)	0.44 (11)	8.00 (203)	4.88 (124)	4.88 (124)	5.5 (140)	5.5 (140)	N/A	N/A
2x2.5x9.5▲	2	2.5	8.00 (203)	7.00 (178)	4.00 (102)	5.88 (149)	2.38 (60)	3.63 (92)	0.69 (17)	0.44 (11)	11.00 (279)	4.75 (121)	4.75 (121)	5.44 (138)	5.44 (138)	N/A	N/A
2x3x11▲	2	3	10.00 (254)	8.00 (203)	5.50 (140)	6.50 (165)	3.23 (82)	3.77 (96)	0.88 (22)	0.50 (13)	16.00 (406)	4.44 (113)	4.44 (113)	5.31 (135)	5.31 (135)	9.13 (232)	9.13 (232)
2x3x13.5▲	2	3	10.00 (254)	9.00 (229)	5.50 (140)	7.25 (184)	3.00 (76)	4.00 (102)	0.88 (22)	0.50 (13)	16.00 (406)	N/A	5.38 (137)	5.38 (137)	5.38 (137)	N/A	N/A
2.5x3x7▲	2.5	3	7.00 (178)	8.00 (203)	4.25 (108)	4.69 (120)	2.63 (67)	2.38 (60)	0.63 (16)	0.44 (11)	8.00 (203)	4.81 (122)	4.81 (122)	4.44 (113)	4.44 (113)	N/A	N/A
2.5x3x9.5▲	2.5	3	8.00 (203)	6.75 (171)	4.00 (102)	6.00 (152)	2.44 (62)	3.56 (90)	0.69 (17)	0.44 (11)	11.00 (279)	4.94 (125)	4.94 (125)	5.56 (141)	5.56 (141)	9.56 (243)	9.56 (243)
2.5x3x13.5▲	2.5	3	10.00 (254)	9.00 (229)	6.00 (152)	8.00 (203)	3.00 (76)	4.00 (102)	0.88 (22)	0.50 (13)	16.00 (406)	N/A	5.5 (140)	5.5 (140)	5.5 (140)	N/A	N/A
3x4x7▲	3	4	7.00 (178)	6.00 (152)	4.13 (105)	5.00 (127)	2.69 (68)	2.31 (59)	0.63 (16)	0.44 (11)	8.00 (203)	4.69 (119)	4.69 (119)	5.31 (135)	5.31 (135)	N/A	N/A
3x4x9.5▲	3	4	8.00 (203)	7.50 (191)	4.75 (121)	6.13 (156)	2.69 (68)	3.31 (84)	0.75 (19)	0.44 (11)	11.00 (279)	4.69 (119)	4.69 (119)	5.31 (135)	5.31 (135)	9.31 (236)	9.31 (236)
3x4x11▲	3	4	10.00 (254)	9.50 (241)	5.50 (140)	7.38 (187)	3.44 (87)	3.56 (91)	0.88 (22)	0.50 (13)	16.00 (406)	4.44 (113)	4.44 (113)	5.31 (135)	5.31 (135)	9.13 (232)	9.13 (232)
3x4x13.5▲	3	4	10.00 (254)	9.50 (241)	5.63 (143)	8.00 (203)	3.13 (80)	3.88 (98)	0.88 (22)	0.50 (13)	16.00 (406)	N/A	N/A	5.44 (138)	5.44 (138)	9.31 (236)	9.31 (236)
4x5x7▲	4	5	8.00 (203)	7.50 (191)	4.94 (125)	5.75 (146)	3.06 (78)	2.94 (75)	0.69 (17)	0.44 (11)	11.00 (279)	4.94 (125)	4.94 (125)	5.56 (141)	5.56 (141)	N/A	N/A
4x5x9.5▲	4	5	10.00 (254)	8.00 (203)	5.00 (127)	7.00 (178)	2.69 (68)	3.31 (84)	0.75 (19)	0.44 (11)	11.00 (279)	4.69 (119)	4.69 (119)	5.31 (135)	5.31 (135)	9.31 (236)	9.31 (236)
4x5x11▲	4	5	10.00 (254)	9.75 (248)	5.56 (141)	7.25 (184)	3.41 (87)	3.59 (91)	0.88 (22)	0.50 (13)	16.00 (406)	4.5 (114)	4.5 (114)	5.38 (137)	5.38 (137)	9.19 (233)	9.19 (233)
4x5x13.5▲	4	5	11.00 (279)	10.00 (254)	6.00 (152)	8.56 (218)	3.25 (83)	3.75 (95)	0.88 (22)	0.50 (13)	16.00 (406)	N/A	N/A	5.06 (129)	5.06 (129)	8.88 (226)	8.88 (226)
5x6x7▲	5	6	10.00 (254)	8.50 (216)	5.81 (148)	6.25 (159)	3.63 (92)	2.38 (60)	0.69 (17)	0.44 (11)	11.00 (279)	5.18 (132)	5.18 (132)	5.81 (148)	5.81 (148)	9.5 (241)	N/A
5x6x9.5▲	5	6	11.00 (279)	10.00 (254)	6.00 (152)	7.50 (191)	3.19 (81)	3.81 (97)	0.88 (22)	0.50 (13)	16.00 (406)	5.06 (129)	5.06 (129)	5.69 (145)	5.69 (145)	9.69 (246)	9.69 (246)
5x6x11▲	5	6	11.00 (279)	10.50 (267)	5.44 (138)	7.94 (202)	3.44 (87)	3.56 (91)	0.88 (22)	0.50 (13)	16.00 (406)	N/A	N/A	5.44 (138)	5.44 (138)	9.25 (235)	9.25 (235)
5x6x13.5▲	5	6	12.00 (305)	13.00 (330)	6.00 (152)	9.00 (229)	5.19 (132)	5.81 (148)	1.00 (25)	0.63 (16)	23.00 (584)	N/A	N/A	5.56 (141)	5.56 (141)	9.38 (238)	9.38 (238)
6x8x9.5▲	6	8	11.00 (279)	10.50 (267)	7.00 (178)	8.25 (210)	4.13 (105)	2.88 (73)	0.88 (22)	0.50 (13)	16.00 (406)	N/A	N/A	6.19 (157)	6.19 (157)	N/A	N/A
6x8x11▲	6	8	12.00 (305)	11.00 (279)	6.13 (156)	8.47 (215)	5.63 (143)	5.38 (137)	1.00 (25)	0.63 (16)	23.00 (584)	N/A	N/A	5.81 (148)	5.81 (148)	N/A	N/A
6x8x13.5▲	6	8	12.63 (321)	13.38 (340)	6.50 (165)	9.31 (237)	5.50 (140)	5.50 (140)	1.00 (25)	0.63 (16)	23.00 (584)	N/A	N/A	8.38 (213)	8.38 (213)	9.44 (240)	9.44 (240)
8x10x13.5▲	8	10	15.00 (381)	14.00 (356)	8.00 (203)	11.00 (279)	5.50 (140)	5.50 (140)	1.00 (25)	0.63 (16)	23.00 (584)	N/A	N/A	8.19 (208)	8.19 (208)	9.25 (235)	9.25 (235)

Frame	Motor Frame		
	AG Approx.	A	D
143JM	10.00 (254)	7.00 (178)	3.50 (89)
145JM	11.00 (279)	7.00 (178)	3.50 (89)
182JM	11.00 (279)	9.00 (229)	4.50 (114)
184JM	12.00 (305)	9.00 (229)	4.50 (114)
213JM	14.00 (356)	10.50 (267)	5.25 (133)
215JM	15.00 (381)	10.50 (267)	5.25 (133)
254JM	17.50 (445)	12.50 (318)	6.25 (159)
256JM	19.00 (483)	12.50 (318)	6.25 (159)
284JM	19.00 (483)	14.00 (356)	7.00 (178)
286JM	21.00 (533)	14.00 (356)	7.00 (178)
324JM	22.00 (559)	16.00 (406)	8.00 (203)
326JM	23.00 (584)	16.00 (406)	8.00 (203)
364JM	26.00 (660)	17.17 (436)	9.00 (229)
365JM	26.00 (660)	17.17 (436)	9.00 (229)
404JM	32.00 (813)	19.92 (506)	10.00 (254)
405JM	32.00 (813)	19.92 (506)	10.00 (254)
364TCZ	24.00 (610)	18.00 (457)	9.00 (229)
365TCZ	24.00 (610)	18.00 (457)	9.00 (229)
404TCZ	27.25 (692)	20.00 (508)	10.00 (254)
405TCZ	28.75 (730)	20.00 (508)	10.00 (254)
444TCZ	31.13 (791)	22.00 (559)	11.00 (279)
445TCZ	31.13 (791)	22.00 (559)	11.00 (279)
447TCZ	39.63 (1006)	22.00 (559)	11.00 (279)
449TCZ	39.63 (1006)	22.00 (559)	11.00 (279)

Model 3804 Pump End Only Product Offering

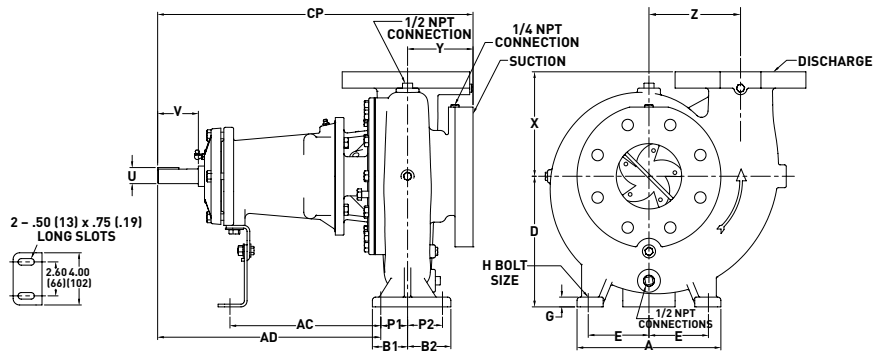

Pump Size	Disch	Suct	D	X	Y	Z	P1	P2	B1	B2	G	H	E	A	AC	AD	CP	U	V	Key
1.25x1.5x7S (NPT)	1.25	1.5	7.00 (178)	5.00 (127)	3.25 (083)	4.50 (114)	1.63 (041)	1.38 (035)	2.63 (067)	2.38 (060)	0.63 (016)	0.44 (011)	3.25 (083)	8.00 (203)	8.35 (212)	12.93 (328)	17.81 (452)	0.88 (022)	2.13 (054)	.19(5) SQ. x 1.38(35) LNG
1.5x2x7S (NPT)	1.5	2	7.00 (178)	6.00 (152)	3.13 (079)	4.63 (117)	1.44 (037)	1.56 (040)	2.44 (062)	2.56 (065)	0.63 (016)	0.44 (011)	3.25 (083)	8.00 (203)	9.03 (229)	13.59 (345)	18.16 (461)	0.88 (022)	2.13 (054)	.19(5) SQ. x 1.38(35) LNG
1.5x2x11S (NPT)	1.5	2	8.00 (203)	9.00● (229)	3.13 (079)	5.75 (146)	1.44 (037)	2.94 (075)	2.25 (057)	3.75 (095)	0.69 (017)	0.44 (011)	4.56 (116)	11.00 (279)	8.92 (227)	13.48 (342)	18.05 (458)	0.88 (022)	2.13 (054)	.19(5) SQ. x 1.38(35) LNG
1.5x2x11L (NPT)	1.5	2	8.00 (203)	9.00● (229)	3.13 (079)	5.75 (146)	1.44 (037)	2.94 (075)	2.25 (057)	3.75 (095)	0.69 (017)	0.44 (011)	4.56 (116)	11.00 (279)	12.19 (310)	18.62 (473)	23.19 (589)	1.13 (029)	3.13 (079)	.25(6) SQ. x 1.75(45) LNG
1.5x2x12S (NPT)	1.5	2	10.00 (254)	7.75 (197)	2.75 (070)	5.75 (146)	1.94 (049)	2.94 (075)	2.87 (073)	3.75 (095)	0.69 (017)	0.44 (011)	4.56 (116)	11.00 (279)	8.60 (218)	13.16 (334)	17.85 (453)	0.88 (022)	2.13 (054)	.19(5) SQ. x 1.38(35) LNG
2x2.5x7S◆	2	2.5	7.00 (178)	6.50 (165)	3.50 (089)	4.75 (005)	1.56 (040)	1.44 (037)	2.56 (065)	2.44 (062)	0.63 (016)	0.44 (011)	3.25 (083)	8.00 (203)	9.08 (231)	13.63 (346)	18.70 (475)	0.88 (022)	2.13 (054)	.19(5) SQ. x 1.38(35) LNG
2x2.5x9.5S◆	2	2.5	8.00 (203)	7.00 (178)	4.00 (102)	5.88 (149)	1.56 (040)	2.81 (071)	2.38 (060)	3.63 (092)	0.69 (017)	0.44 (011)	4.56 (116)	11.00 (279)	8.94 (227)	13.50 (343)	19.07 (484)	0.88 (022)	2.13 (054)	.19(5) SQ. x 1.38(35) LNG
2x2.5x9.5L◆	2	2.5	8.00 (203)	7.00 (178)	4.00 (102)	5.88 (149)	1.56 (040)	2.81 (071)	2.38 (060)	3.63 (092)	0.69 (017)	0.44 (011)	4.56 (116)	11.00 (279)	11.85 (301)	17.69 (449)	23.22 (590)	1.13 (029)	3.13 (079)	.25(6) SQ. x 1.75(45) LNG
2x3x11S◆	2	3	10.00 (254)	8.00 (203)	5.50 (140)	6.50 (165)	2.23 (057)	2.77 (070)	3.23 (082)	3.77 (096)	0.88 (022)	0.50 (013)	7.00 (178)	16.00 (406)	7.93 (201)	12.52 (318)	20.22 (514)	0.88 (022)	2.13 (054)	.19(5) SQ. x 1.38(35) LNG
2x3x11L◆	2	3	10.00 (254)	8.00 (203)	5.50 (140)	6.50 (165)	2.23 (057)	2.77 (070)	3.23 (082)	3.77 (096)	0.88 (022)	0.50 (013)	7.00 (178)	16.00 (406)	11.06 (281)	16.87 (428)	24.59 (625)	1.13 (029)	3.13 (079)	.25(6) SQ. x 1.75(45) LNG
2x3x13.5L◆	2	3	10.00 (254)	9.00 (229)	5.50 (140)	7.25 (184)	2.00 (051)	3.00 (076)	3.00 (076)	4.00 (102)	0.88 (022)	0.50 (013)	7.00 (178)	16.00 (406)	11.34 (288)	17.25 (438)	24.65 (626)	1.13 (029)	3.13 (079)	.25(6) SQ. x 1.75(45) LNG
2.5x3x7S◆	2.5	3	7.00 (178)	6.00 (152)	4.25 (108)	4.69 (005)	1.63 (041)	1.38 (035)	2.63 (067)	2.38 (060)	0.63 (016)	0.44 (011)	3.25 (083)	8.00 (203)	8.94 (227)	13.50 (343)	19.38 (492)	0.88 (022)	2.13 (054)	.19(5) SQ. x 1.38(35) LNG
2.5x3x9.5S◆	2.5	3	8.00 (203)	6.75 (171)	4.00 (102)	6.00 (152)	1.63 (041)	2.75 (070)	2.44 (062)	3.56 (090)	0.69 (017)	0.44 (011)	4.56 (116)	11.00 (279)	9.03 (229)	13.62 (346)	19.22 (488)	0.88 (022)	2.13 (054)	.19(5) SQ. x 1.38(35) LNG
2.5x3x9.5L◆	2.5	3	8.00 (203)	6.75 (171)	4.00 (102)	6.00 (152)	1.63 (041)	2.75 (070)	2.44 (062)	3.56 (090)	0.69 (017)	0.44 (011)	4.56 (116)	11.00 (279)	11.93 (303)	17.75 (451)	23.37 (594)	1.13 (029)	3.13 (079)	.25(6) SQ. x 1.75(45) LNG

S - denotes small power frame
 L - denotes large power frame
 XL - denotes extra large power frame

Notes:

- Dimensions are approximate.
- All dimensions are in inches (mm) and may vary ± 1/4 (6).
- Not for construction purposes unless certified.
 - ◆ Available in 250 lb./125 lb. Flanges
 - Dimensions do not match Bell & Gossett
- Use extra large power frame with impeller diameters larger than 12.5 (318).
- See 3800 dimension pages for base mount information.

Model 3804 Pump End Only Product Offering

Pump Size	Disch	Suct	D	X	Y	Z	P1	P2	B1	B2	G	H	E	A	AC	AD	CP	U	V	Key
2.5x3x13.5L◆	2.5	3	10.00 (254)	9.00 (229)	6.00 (152)	8.00 (203)	2.00 (051)	3.00 (076)	3.00 (076)	4.00 (102)	0.88 (022)	0.50 (013)	7.00 (178)	16.00 (406)	11.47 (291)	17.28 (439)	25.28 (642)	1.13 (029)	3.13 (079)	.25(6) SQ. x 1.75(45) LNG
3x4x7S◆	3	4	7.00 (178)	6.00 (152)	4.13 (105)	5.00 (127)	1.69 (043)	1.31 (033)	2.69 (068)	2.31 (059)	0.63 (016)	0.44 (011)	3.25 (083)	8.00 (203)	8.73 (222)	13.24 (336)	19.11 (485)	0.88 (022)	2.13 (054)	.19(5) SQ. x 1.39(35) LNG
3x4x7L◆	3	4	7.00 (178)	6.00 (152)	4.13 (105)	5.00 (127)	1.69 (043)	1.31 (033)	2.69 (068)	2.31 (059)	0.63 (016)	0.44 (011)	3.25 (083)	8.00 (203)	11.60 (295)	17.43 (443)	23.22 (590)	1.13 (029)	3.13 (079)	.25(6) SQ. x 1.75(45) LNG
3x4x9.5S◆	3	4	8.00 (203)	7.50 (191)	4.75 (121)	6.13 (156)	1.81 (046)	2.56 (065)	2.69 (068)	3.31 (084)	0.75 (019)	0.44 (011)	4.56 (116)	11.00 (279)	8.54 (217)	13.19 (335)	19.72 (501)	0.88 (022)	2.13 (054)	.19(5) SQ. x 1.39(35) LNG
3x4x9.5L◆	3	4	8.00 (203)	7.50 (191)	4.75 (121)	6.13 (156)	1.81 (046)	2.56 (065)	2.69 (068)	3.31 (084)	0.75 (019)	0.44 (011)	4.56 (116)	11.00 (279)	11.50 (292)	17.32 (440)	23.87 (606)	1.13 (029)	3.13 (079)	.25(6) SQ. x 1.75(45) LNG
3x4x11S◆	3	4	10.00 (254)	9.50 (241)	5.50 (140)	7.38 (187)	2.44 (062)	2.56 (065)	3.44 (087)	3.56 (091)	0.88 (022)	0.50 (013)	7.00 (178)	16.00 (406)	7.71 (196)	12.31 (313)	20.22 (514)	0.88 (022)	2.13 (054)	.19(5) SQ. x 1.39(35) LNG
3x4x11L◆	3	4	10.00 (254)	9.50 (241)	5.50 (140)	7.38 (187)	2.44 (062)	2.56 (065)	3.44 (087)	3.56 (091)	0.88 (022)	0.50 (013)	7.00 (178)	16.00 (406)	10.84 (275)	16.69 (424)	24.59 (625)	1.13 (029)	3.13 (079)	.25(6) SQ. x 1.75(45) LNG
3x4x13.5L◆	3	4	10.00 (254)	9.50 (241)	5.63 (143)	8.00 (203)	2.13 (054)	2.88 (073)	3.13 (080)	3.88 (098)	0.88 (022)	0.50 (013)	7.00 (178)	16.00 (406)	11.28 (287)	17.12 (435)	24.84 (631)	1.13 (029)	3.13 (079)	.25(6) SQ. x 1.75(45) LNG
4x5x7S◆	4	5	8.00 (203)	7.50 (191)	4.94 (125)	5.75 (146)	2.25 (057)	2.13 (054)	3.06 (078)	2.94 (075)	0.69 (017)	0.44 (011)	4.56 (116)	11.00 (279)	8.40 (213)	12.94 (329)	20.16 (512)	0.88 (022)	2.13 (054)	.19(5) SQ. x 1.39(35) LNG
4x5x7L◆	4	5	8.00 (203)	7.50 (191)	4.94 (125)	5.75 (146)	2.25 (057)	2.13 (054)	3.06 (078)	2.94 (075)	0.69 (017)	0.44 (011)	4.56 (116)	11.00 (279)	11.28 (287)	17.06 (433)	24.28 (617)	1.13 (029)	3.13 (079)	.25(6) SQ. x 1.75(45) LNG
4x5x9.5S◆	4	5	10.00 (254)	8.00 (203)	5.00 (127)	7.00 (178)	1.88 (048)	2.50 (064)	2.69 (068)	3.31 (084)	0.75 (019)	0.44 (011)	4.56 (116)	11.00 (279)	8.52 (216)	13.12 (333)	19.97 (507)	0.88 (022)	2.13 (054)	.19(5) SQ. x 1.39(35) LNG
4x5x9.5L◆	4	5	10.00 (254)	8.00 (203)	5.00 (127)	7.00 (178)	1.88 (048)	2.50 (064)	2.69 (068)	3.31 (084)	0.75 (019)	0.44 (011)	4.56 (116)	11.00 (279)	11.43 (290)	17.25 (438)	24.12 (613)	1.13 (029)	3.13 (079)	.25(6) SQ. x 1.75(45) LNG
4x5x11S◆	4	5	10.00 (254)	9.75 (248)	5.56 (141)	7.25 (184)	2.41 (061)	2.94 (075)	3.59 (091)	3.59 (091)	0.88 (022)	0.50 (013)	7.00 (178)	16.00 (406)	7.81 (198)	12.41 (315)	20.35 (517)	0.88 (022)	2.13 (054)	.19(5) SQ. x 1.39(35) LNG
4x5x11L◆	4	5	10.00 (254)	9.75 (248)	5.56 (141)	7.25 (184)	2.41 (061)	2.94 (075)	3.59 (091)	3.59 (091)	0.88 (022)	0.50 (013)	7.00 (178)	16.00 (406)	10.94 (278)	16.78 (426)	24.72 (628)	1.13 (029)	3.13 (079)	.25(6) SQ. x 1.75(45) LNG
4x5x11XL◆	4	5	10.00 (254)	9.75 (248)	5.56 (141)	7.25 (184)	2.41 (061)	2.59 (066)	3.41 (087)	3.59 (091)	0.88 (022)	0.50 (013)	7.00 (178)	16.00 (406)	15.38 (391)	24.52 (623)	32.49 (825)	2.38 (060)	5.50 (140)	.63(16) SQ. x 4.00(102) LNG
4x5x13.5L◆	5	5	11.00 (279)	10.00 (254)	6.00 (152)	8.56 (218)	2.25 (057)	2.75 (070)	3.25 (083)	3.75 (095)	0.88 (022)	0.50 (013)	7.00 (178)	16.00 (406)	10.78 (274)	16.63 (422)	24.84 (631)	1.13 (029)	3.13 (079)	.25(6) SQ. x 1.75(45) LNG
4x5x13.5XL◆	5	5	11.00 (279)	10.00 (254)	6.00 (152)	8.56 (218)	2.25 (057)	2.75 (070)	3.25 (083)	3.75 (095)	0.88 (022)	0.50 (013)	7.00 (178)	16.00 (406)	15.25 (387)	24.38 (619)	32.63 (829)	2.38 (060)	5.50 (140)	.63(16) SQ. x 4.00(102) LNG
5x6x7S◆	5	6	10.00 (254)	8.50 (216)	5.81 (148)	6.25 (159)	2.81 (071)	1.56 (040)	3.63 (092)	2.38 (060)	0.69 (018)	0.44 (011)	4.56 (116)	11.00 (279)	8.09 (205)	12.63 (321)	21.28 (541)	0.88 (022)	2.13 (054)	.19(5) SQ. x 1.39(35) LNG
5x6x7L◆	5	6	10.00 (254)	8.50 (216)	5.81 (148)	6.25 (159)	2.81 (071)	1.56 (040)	3.63 (092)	2.38 (060)	0.69 (018)	0.44 (011)	4.56 (116)	11.00 (279)	10.97 (279)	16.76 (426)	25.39 (645)	1.13 (029)	3.13 (079)	.25(6) SQ. x 1.75(45) LNG
5x6x9.5S◆	5	6	11.00 (279)	10.00 (254)	6.00 (152)	7.50 (191)	2.19 (056)	2.81 (071)	3.19 (081)	3.81 (097)	0.88 (022)	0.50 (013)	7.00 (178)	16.00 (406)	8.59 (218)	13.19 (335)	21.34 (542)	0.88 (022)	2.13 (054)	.19(5) SQ. x 1.39(35) LNG
5x6x9.5L◆	5	6	11.00 (279)	10.00 (254)	6.00 (152)	7.50 (191)	2.19 (056)	2.81 (071)	3.19 (081)	3.81 (097)	0.88 (022)	0.50 (013)	7.00 (178)	16.00 (406)	11.50 (292)	17.31 (440)	25.50 (648)	1.13 (029)	3.13 (079)	.25(6) SQ. x 1.75(45) LNG
5x6x11L◆	5	6	11.00 (279)	10.50 (267)	5.44 (138)	7.94 (202)	2.59 (066)	2.41 (061)	3.44 (087)	3.56 (091)	0.88 (022)	0.50 (013)	7.00 (178)	16.00 (406)	10.82 (275)	16.72 (425)	24.65 (626)	1.13 (029)	3.13 (079)	.25(6) SQ. x 1.75(45) LNG
5x6x13.5L◆	5	6	12.00 (305)	13.00 (330)	6.00 (152)	9.00 (229)	4.19 (106)	4.81 (122)	5.19 (132)	5.81 (148)	1.00 (025)	0.63 (016)	10.50 (267)	23.00 (584)	9.34 (237)	15.19 (386)	25.34 (644)	1.13 (029)	3.13 (079)	.25(6) SQ. x 1.75(45) LNG
5x6x13.5XL◆	5	6	12.00 (305)	13.00 (330)	6.00 (152)	9.00 (229)	4.19 (106)	4.81 (122)	5.19 (132)	5.81 (148)	1.00 (025)	0.63 (016)	10.50 (267)	23.00 (584)	13.81 (351)	22.94 (583)	33.13 (842)	2.38 (060)	5.50 (140)	.63(16) SQ. x 4.00(102) LNG
6x8x9.5L◆	6	8	11.00 (279)	10.50 (267)	7.00 (178)	8.25 (210)	3.13 (079)	1.88 (048)	4.13 (105)	2.88 (073)	0.88 (022)	0.50 (013)	7.00 (178)	16.00 (406)	11.06 (281)	16.93 (430)	27.00 (686)	1.13 (029)	3.13 (079)	.25(6) SQ. x 1.75(45) LNG
6x8x11L◆	6	8	12.00 (305)	11.00 (279)	6.13 (156)	8.47 (215)	4.63 (117)	4.38 (111)	5.63 (143)	5.38 (137)	1.00 (025)	0.63 (016)	10.50 (267)	23.00 (584)	9.15 (232)	15.05 (382)	25.72 (653)	1.13 (029)	3.13 (079)	.25(6) SQ. x 1.75(45) LNG
6x8x13.5XL◆	6	8	12.63● (321)	13.38● (340)	6.50 (165)	9.31 (237)	4.50 (114)	4.50 (114)	5.50 (140)	5.50 (140)	1.00 (025)	0.63 (016)	10.50 (267)	23.00 (584)	13.44 (341)	22.56 (573)	33.57 (853)	2.38 (060)	5.50 (140)	.63(16) SQ. x 4.00(102) LNG
8x10x13.5XL◆	8	10	15.00 (381)	14.00 (356)	8.00 (203)	11.00 (279)	4.50 (114)	4.50 (114)	5.50 (140)	5.50 (140)	1.00 (025)	0.63 (016)	10.50 (267)	23.00 (584)	13.33 (339)	22.38 (568)	34.96 (888)	2.38 (060)	5.50 (140)	.63(16) SQ. x 4.00(102) LNG

S - denotes small power frame
L - denotes large power frame
XL - denotes extra large power frame

- Notes:**
- Dimensions are approximate.
 - All dimensions are in inches (mm) and may vary ± 1/4 (6).
 - Not for construction purposes unless certified.
 - Available in 250 lb./125 lb. Flanges
 - Dimensions do not match Bell & Gossett

- Use extra large power frame with impeller diameters larger than 12.5 (318).
- See 3800 dimension pages for base mount information.

3550 and 1770 RPM Range Charts

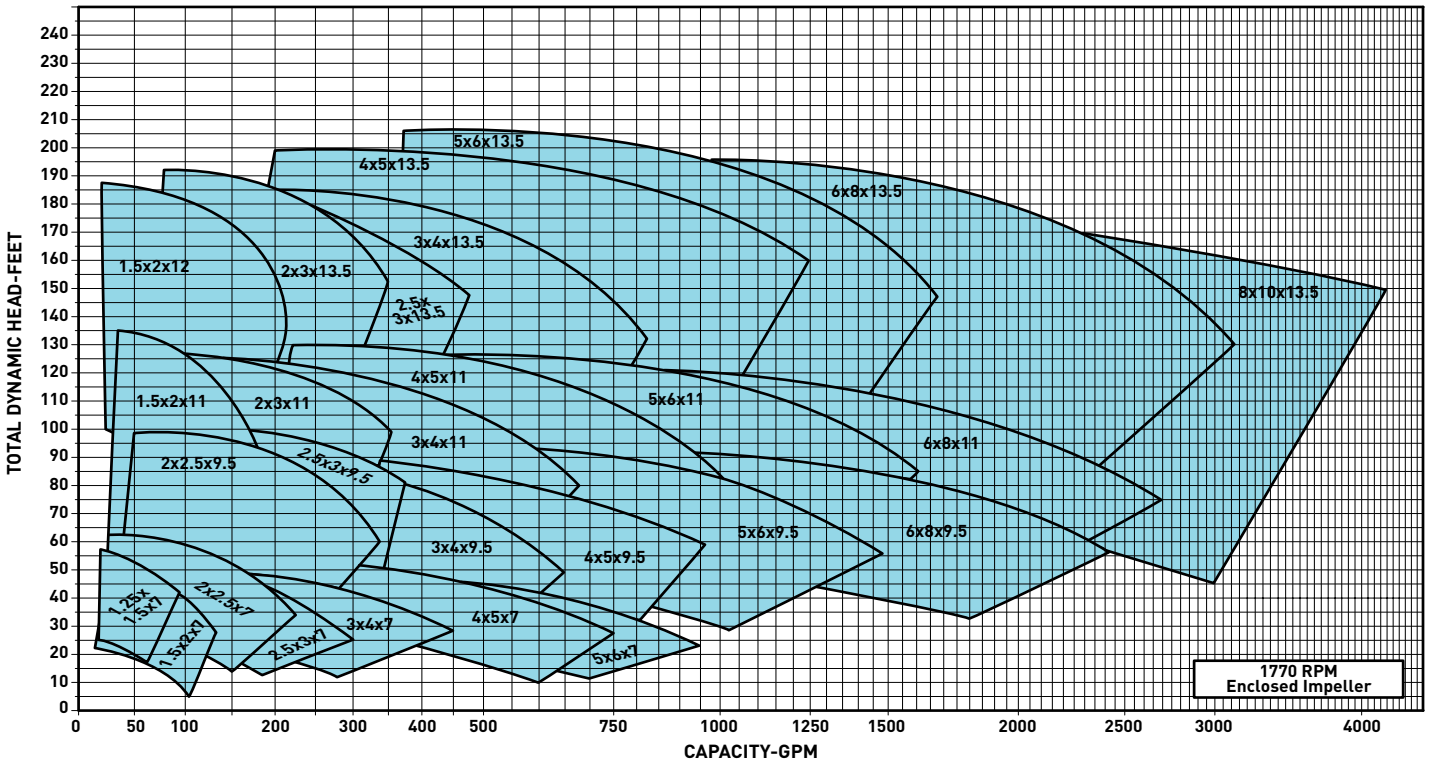
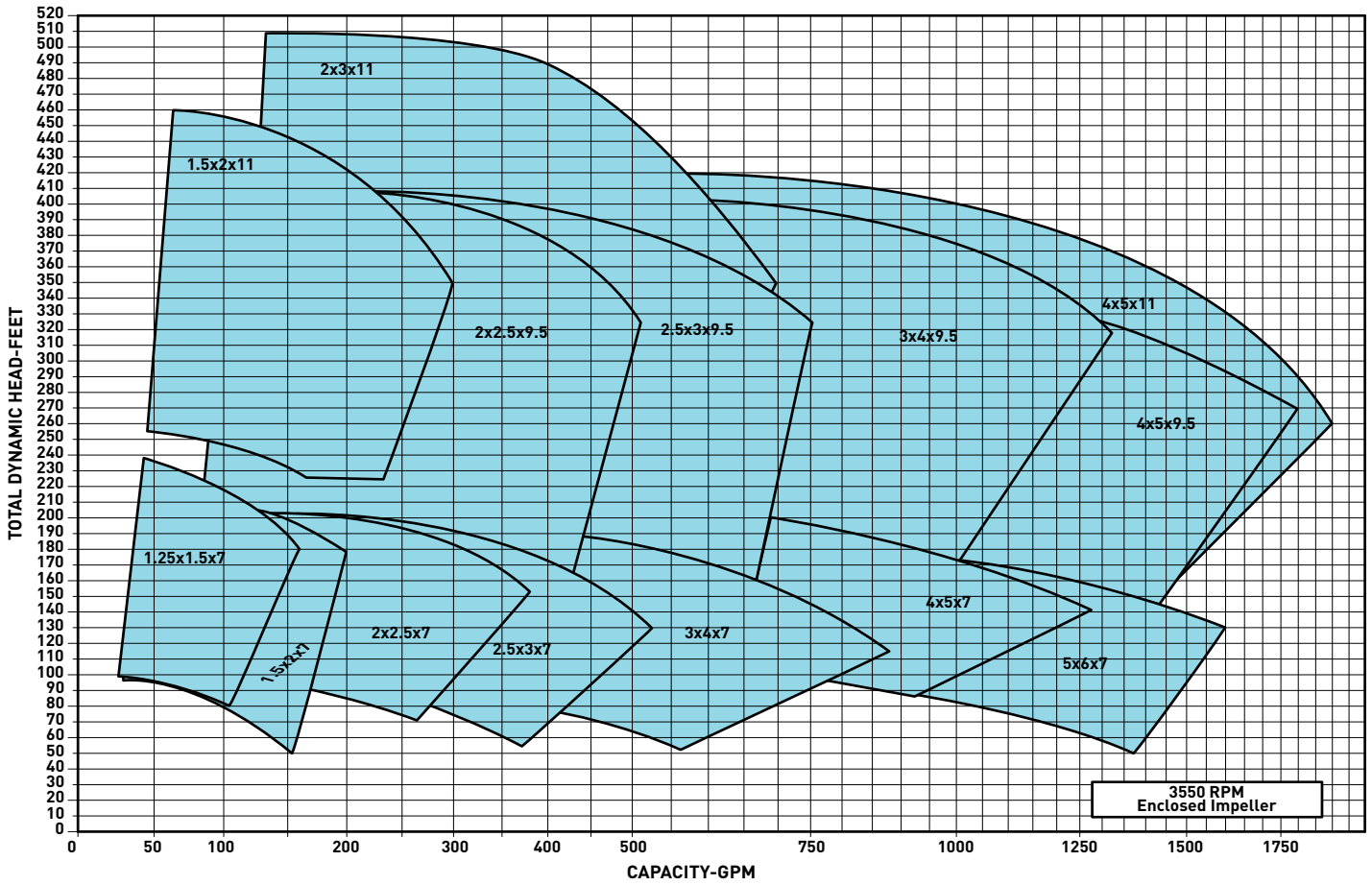

2950 and 1475 RPM Range Charts

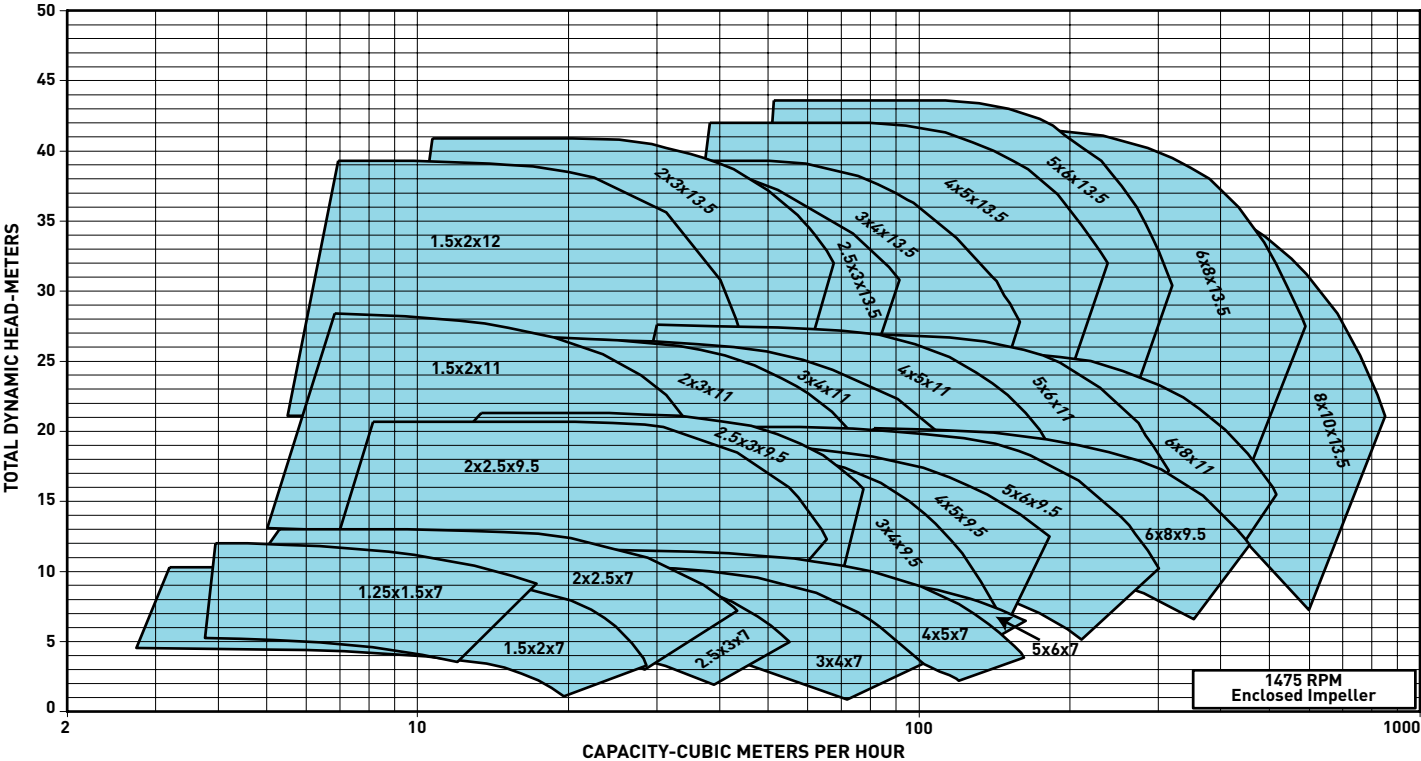
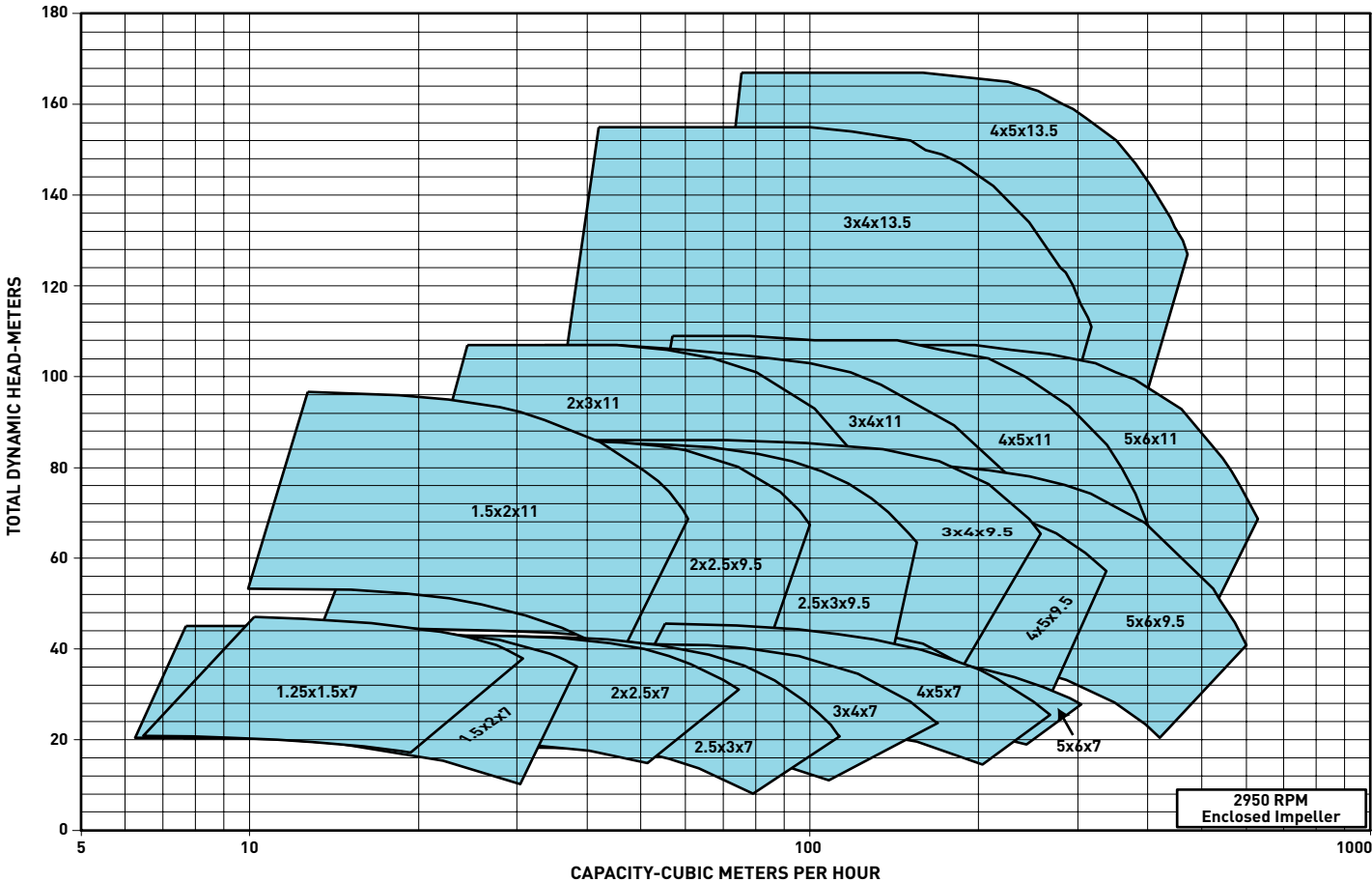

Engineering Specifications

3800 Series Specifications

The contractor shall furnish (and install as shown on the plans) Aurora® model (3801 horizontal close coupled) (3804 horizontal flexible coupled) back pullout centrifugal pump size ___ x ___ x ___ of stainless fitted construction.

Each pump shall have a capacity of ___ gpm at ___ ft. of total head, with a temperature of ___ ° F, ___ specific gravity. Each pump is to be furnished with a mechanical seal with all metal parts to be 303 stainless steel with Buna-N elastomers, ceramic seat and carbon washer. The unit must be equipped with stainless steel shaft sleeve that extends the length of the seal plate. The pump shaft extension shall be gasket sealed from the pumped liquid. Impellers to be 316 stainless steel, dynamically balanced and key locked to the shaft.

Flexible Coupled-Frame Mounted (3804)

Pump and motor are to be mounted on a common fabricated steel base plate. The shaft is to be steel, installed in a cast iron power frame. Pumps shall have a shaft design of .002" deflection at the seal face with the pump running under maximum load condition. Grease ball bearings have a 3-year minimum life (AFBMA B10) under the maximum condition of load. The pump shall be flexible coupled to a standard horizontal NEMA ___ hp, ___ phase, ___ Hertz, ___ volts, ___ rpm (open drip-proof) (totally enclosed fan cooled) motor. Alignment shall be checked in accordance with the standards of the Hydraulic Institute after installation and there shall be no strain transmitted to the pumps.

Materials of Construction

Pump Part	Stainless Fitted
Casing	Cast iron ASTM A48
Impeller	316 SST
Seal plate/motor bracket	Cast iron ASTM A48
Shaft (3804)	Steel AISI C1045
Sleeve	316 SST
Power frame (3804) (PF1, PF2, PF3 or PF21A)	Cast iron ASTM A48
Mechanical seal	303 SST metal parts, Buna-N elastomer parts, ceramic seat and carbon washer

Design Details

Area	Description	Power Frame			
		1	2	3	21A
Pump Shaft	Rotation - from driver end	CW	CW	CW	CW
	Diameter at impeller	0.88	1.25	1.25	1.63
	Diameter at shaft sleeve	1.00	1.38	1.38	1.75
	Diameter between bearings	1.38	1.94	2.38	3.25
	Diameter at coupling end	0.88	1.13	1.13	2.38
	Coupling key - square	0.19	0.25	0.25	0.63
	Max. deflection at seal face	0.002	0.002	0.002	0.002
Ball Bearings	Bearing (inboard radial)	206K	308K	310K	313
	Bearing (outboard thrust)	206KG	308KG	310KG	5313
	Bearing centers	5.69	7.69	7.69	9.63
	Bearing type	Ball	Ball	Ball	Ball
	Min B10 bearing life under maximum load	3 years	3 years	3 years	3 years
Sleeve	Outside diameter of sleeve	1.13	1.50	1.50	2.00



800 Airport Road | North Aurora, Illinois 60542 | www.AuroraPump.com

All Pentair trademarks and logos are owned by Pentair. All other brands or product names are trademarks or registered marks of their respective owners. Because we are continuously improving our products and services, Pentair reserves the right to change specifications without prior notice. Pentair is an equal opportunity employer.

A-02-1049 (08/22/18) ©2018 Pentair plc. All Rights Reserved.