

2 x 2-1/2 x 12A SERIES 420

ENCLOSED IMPELLER

Section **420** Page **401**

Date **January 2001**

Supersedes Section 420 Page 401

Dated January 1968

SIZE : 2x2-1/2x12A

TYPE : 420

IMPELLER : Enclosed

R. P. M. : 3500

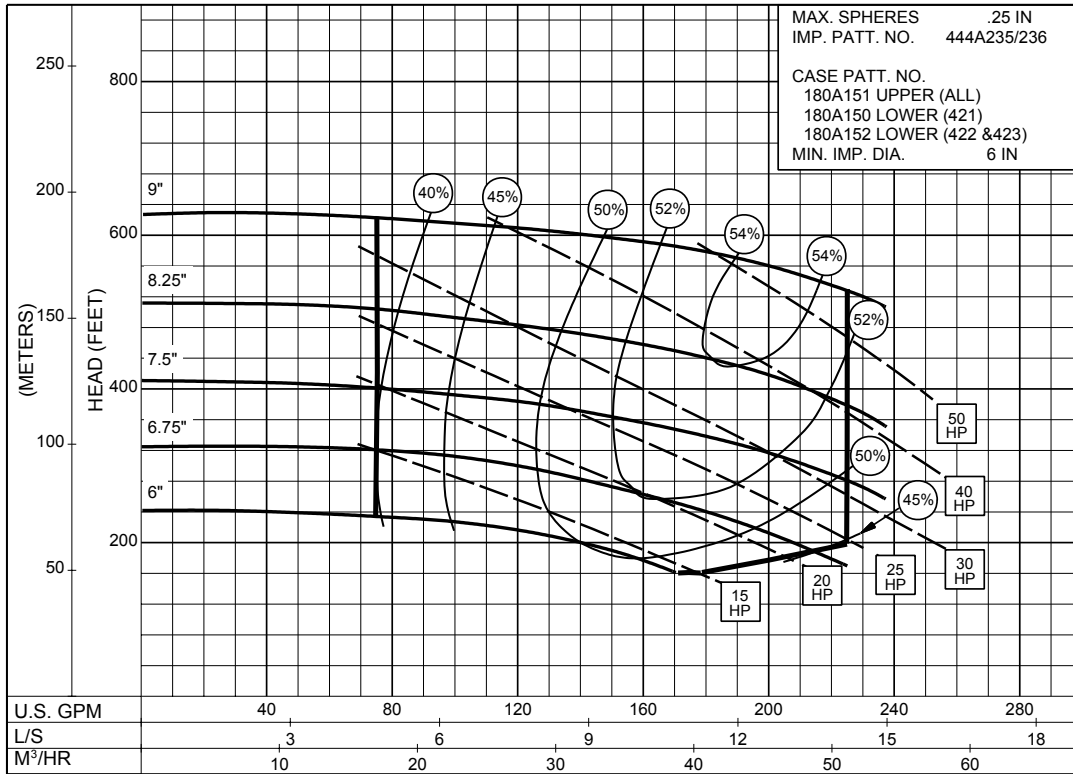

1PC-115893

3500
R.P.M

SIZE : 2x2-1/2x12A

TYPE : 420

IMPELLER : Enclosed

R. P. M. : 1750

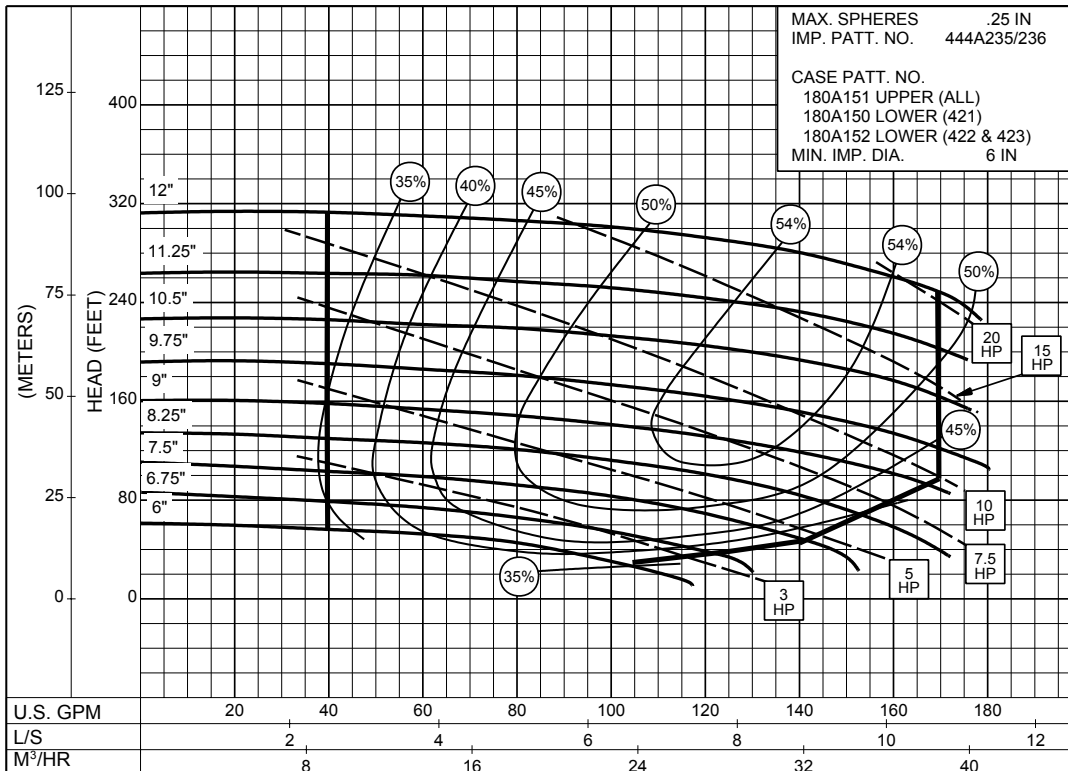

1PC-115894

1750
R.P.M

ENCLOSED IMPELLER

Supersedes Section 420 Page 402
 Dated January 1968

SIZE : 2x2-1/2x12B TYPE : 420 IMPELLER : Enclosed R. P. M. : 1750

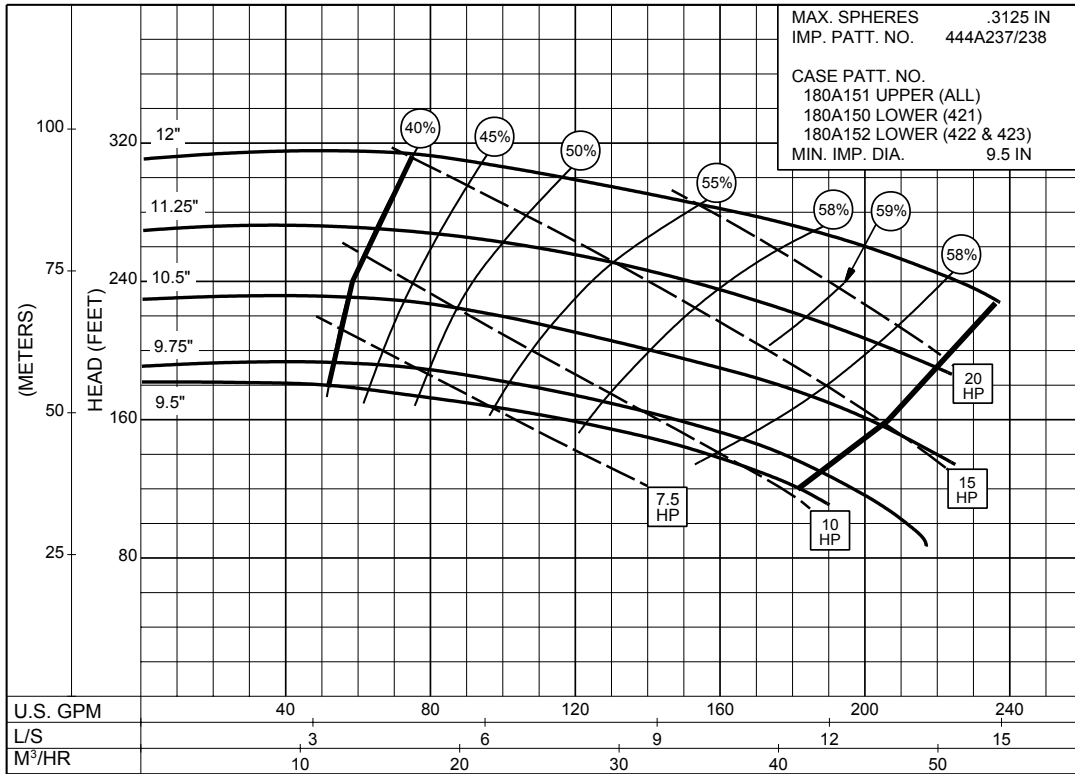

**1750
R.P.M**

1PC-115895

ENCLOSED IMPELLER

Date **January 2001**

Supersedes Section 420 Page 403

Dated January 1968

SIZE : 2-1/2x3x12A

TYPE : 420

IMPELLER : Enclosed

R. P. M. : 3500

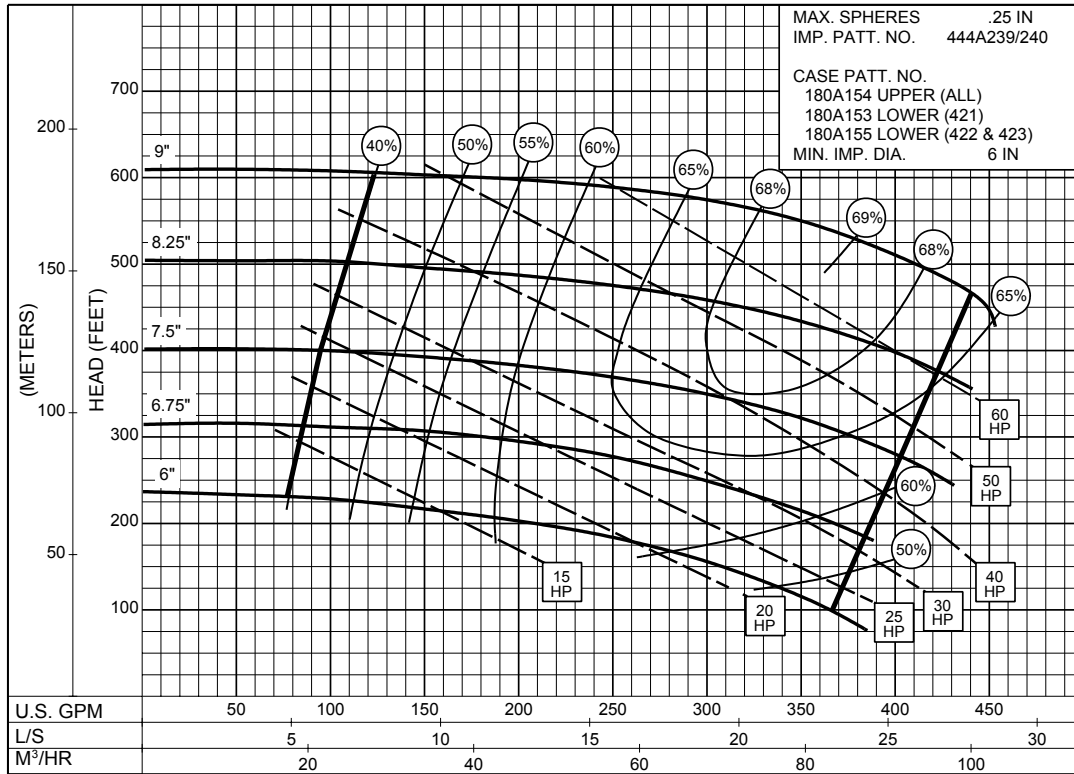

3500
R.P.M

1PC-115896

SIZE : 2-1/2x3x12A

TYPE : 420

IMPELLER : Enclosed

R. P. M. : 1750

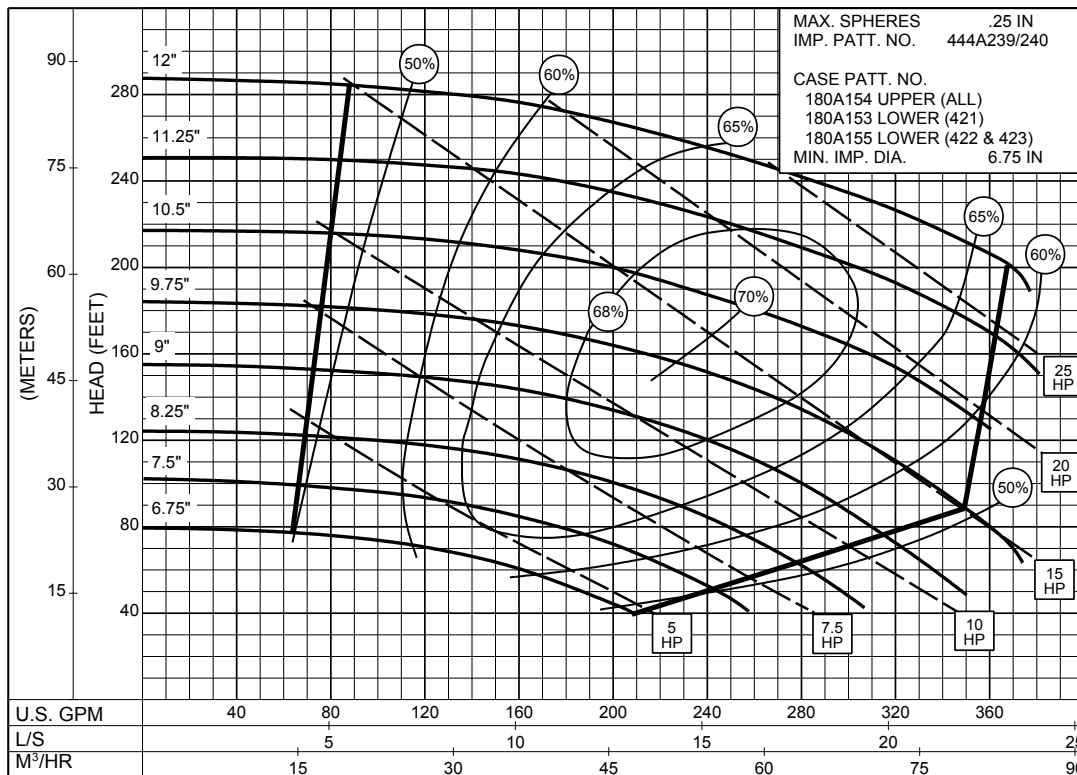

1750
R.P.M

1PC-115897

SIZE : 2-1/2x3x12A

TYPE : 420

IMPELLER : Enclosed

R. P. M. : 1150

MAX. SPHERES .25 IN
 IMP. PATT. NO. 444A239/240
 CASE PATT. NO.
 180A154 UPPER (ALL)
 180A153 LOWER (421)
 180A155 LOWER (422 & 423)
 MIN. IMP. DIA. 7.5 IN

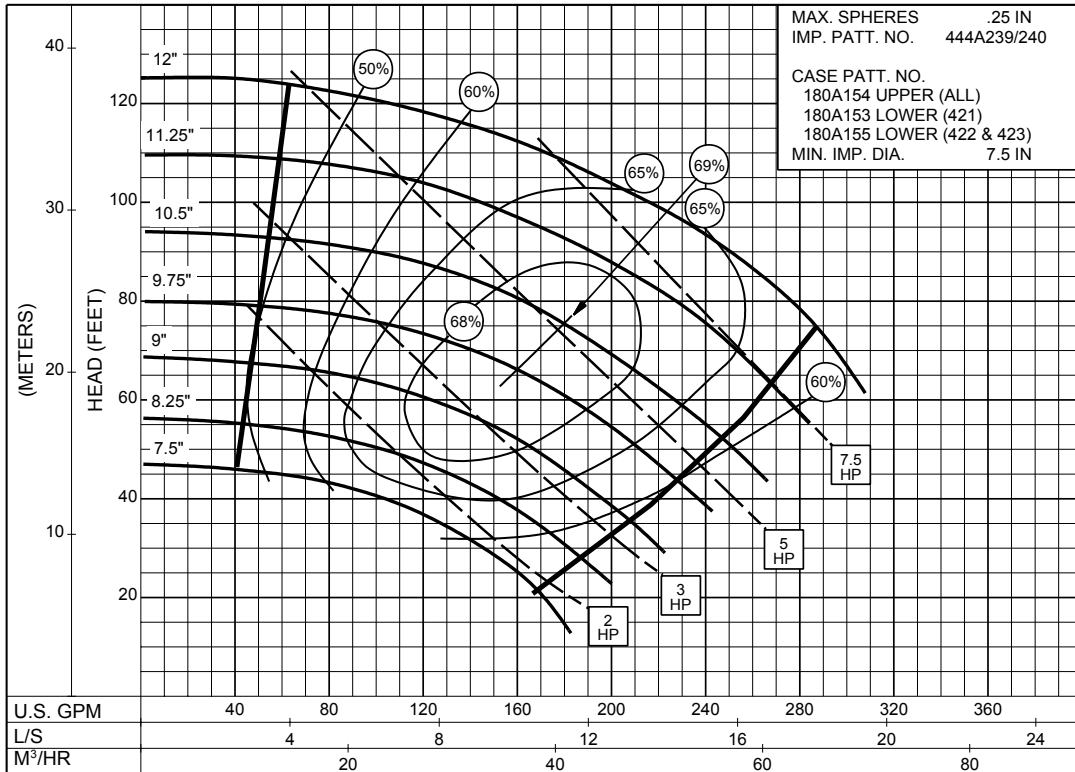

1150
R.P.M

1PC-115898

3 x 4 x 14A SERIES 420

ENCLOSED IMPELLER

SIZE : 3x4x14A TYPE : 420 IMPELLER : Enclosed R. P. M. : 1750

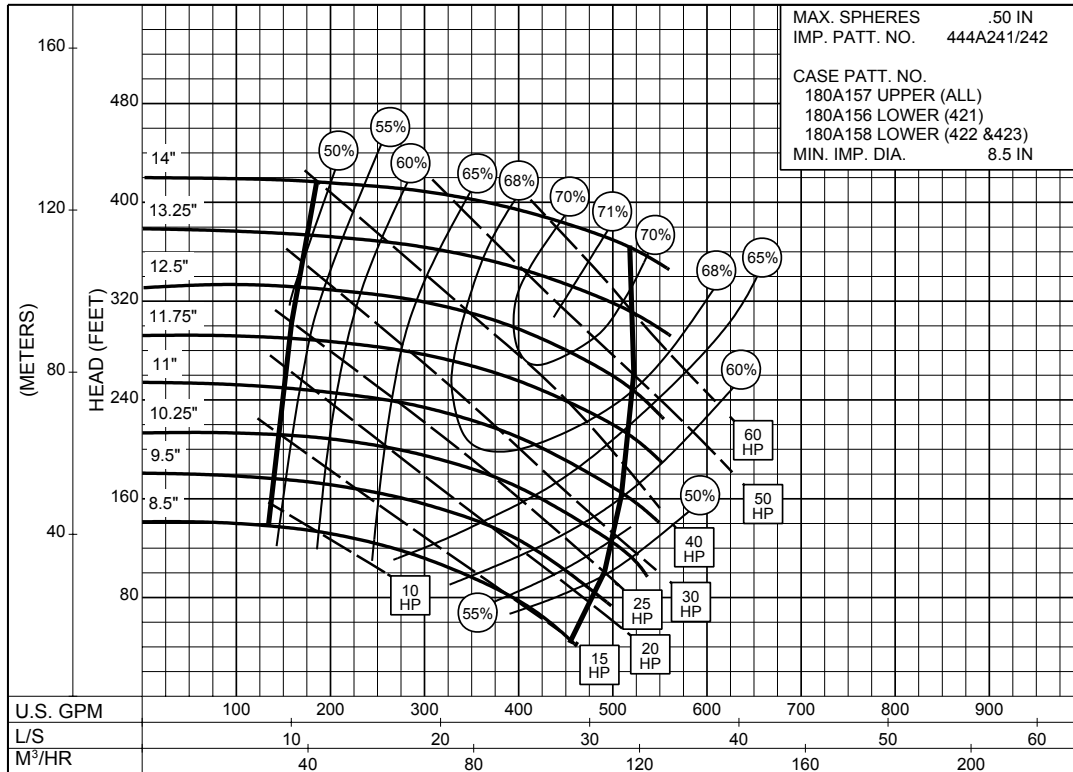

1PC-115899

1750
R.P.M

SIZE : 3x4x14A TYPE : 420 IMPELLER : Enclosed R. P. M. : 1150

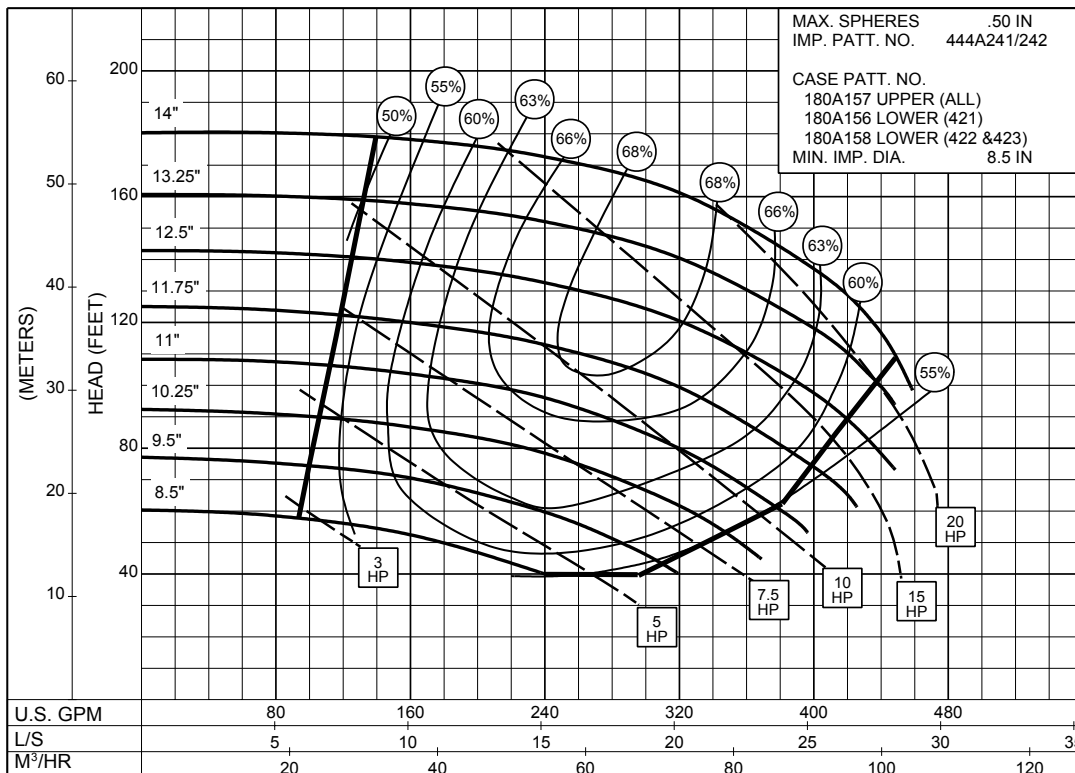

1PC-115900

1150
R.P.M

3 x 4 x 14B SERIES 420

ENCLOSED IMPELLER

SIZE : 3x4x14B

TYPE : 420

IMPELLER : Enclosed

R. P. M. : 1750

MAX. SPHERES .438 IN
 IMP. PATT. NO. 444A243/244
 CASE PATT. NO.
 180A157 UPPER (ALL)
 180A156 LOWER (421)
 180A158 LOWER (422 & 423)
 MIN. IMP. DIA. 10.5 IN

1750
R.P.M

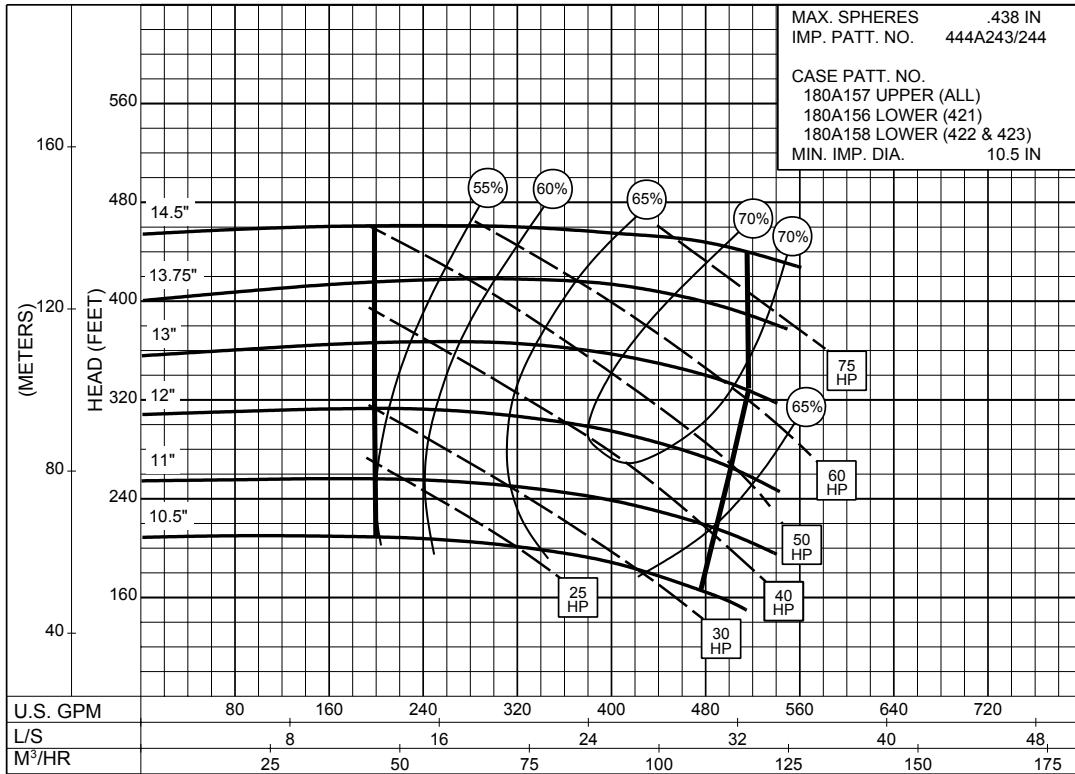

1PC-118277

4 x 5 x 15 SERIES 420

ENCLOSED IMPELLER

SIZE : 4x5x15

TYPE : 420

IMPELLER : Enclosed

R. P. M. : 1750

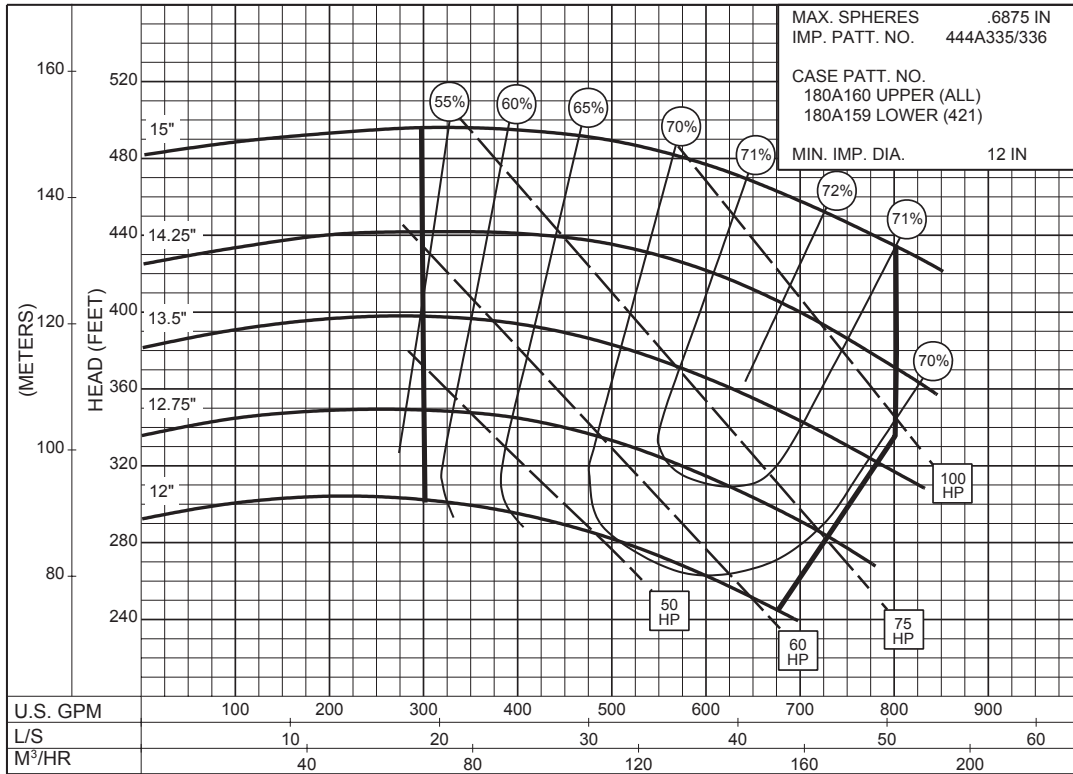

1PC-115902

1750
R.P.M

SIZE : 4x5x15

TYPE : 420

IMPELLER : Enclosed

R. P. M. : 1150

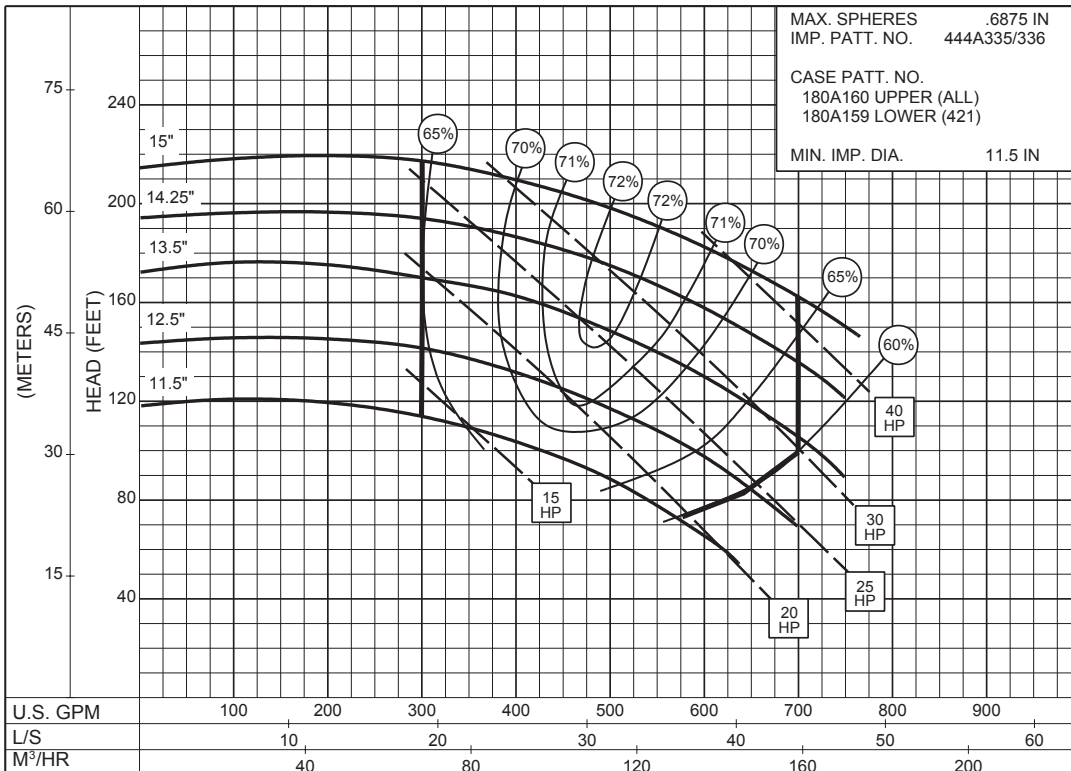

1PC-115903

1150
R.P.M

5 x 5 x 12 SERIES 420

ENCLOSED IMPELLER

SIZE : 5x5x12 TYPE : 420 IMPELLER : Enclosed R. P. M. : 3550

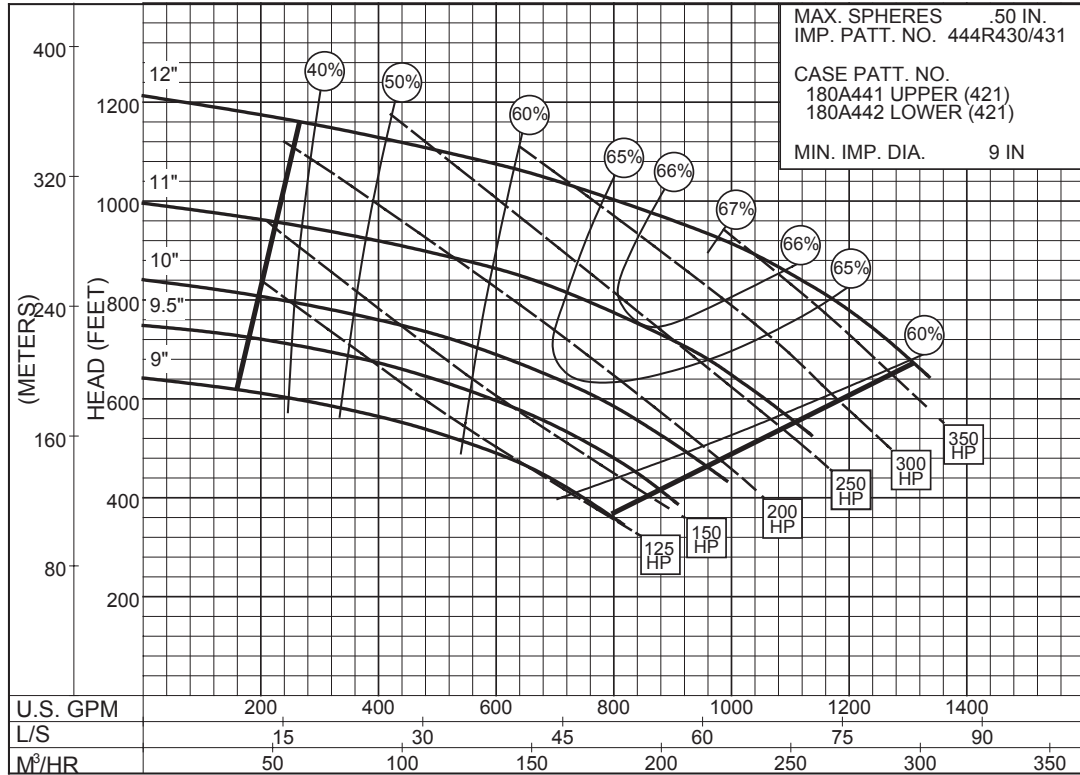

3550
R.P.M

PC-175888

5 x 6 x 15 SERIES 420

ENCLOSED IMPELLER

SIZE : 5x6x15

TYPE : 420

IMPELLER : Enclosed

R. P. M. : 1750

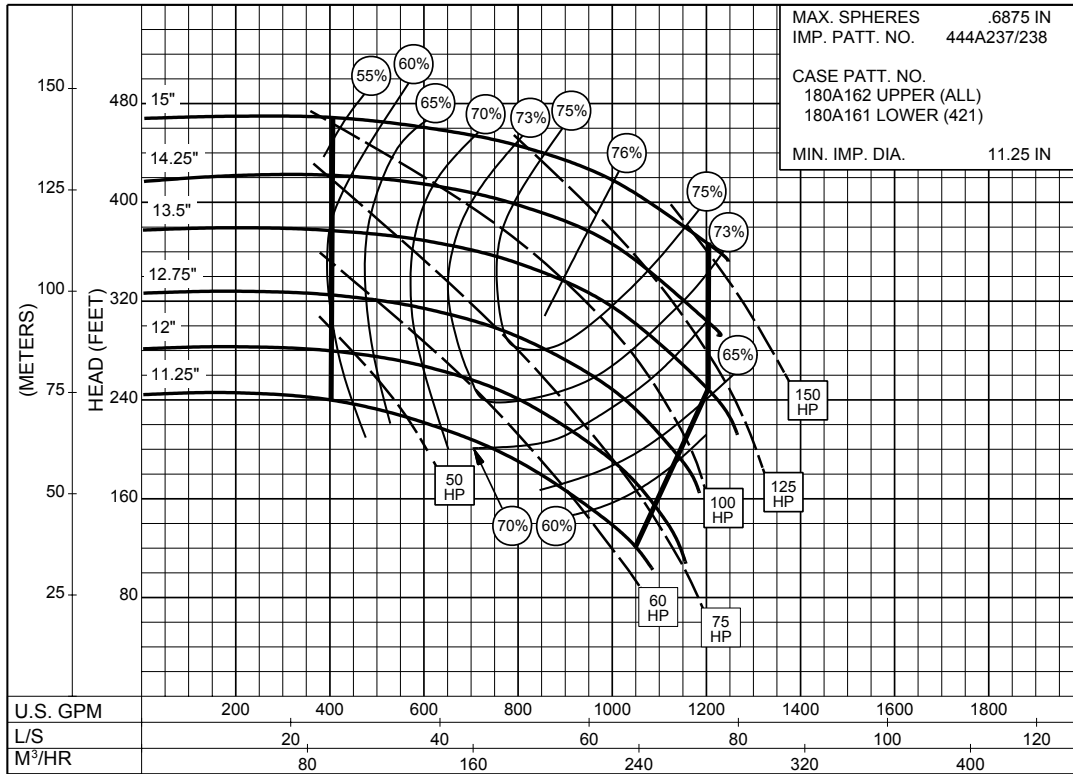

1750
R.P.M

1PC-115904

6 x 6 x 12 SERIES 420

ENCLOSED IMPELLER

SIZE : 6x6x12 TYPE : 420 IMPELLER : Enclosed R. P. M. : 3550

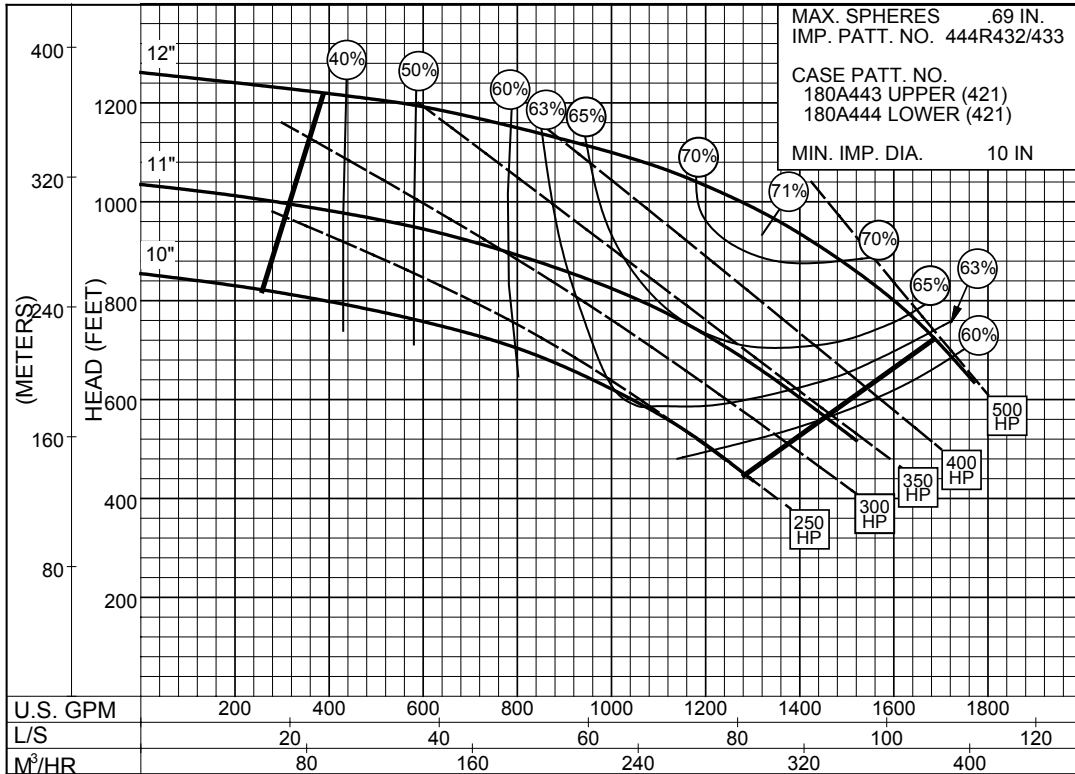

PC-175890

3550
R.P.M

6 x 8 x 17A SERIES 420

ENCLOSED IMPELLER

SIZE : 6x8x17A

TYPE : 420

IMPELLER : Enclosed

R. P. M. : 1750

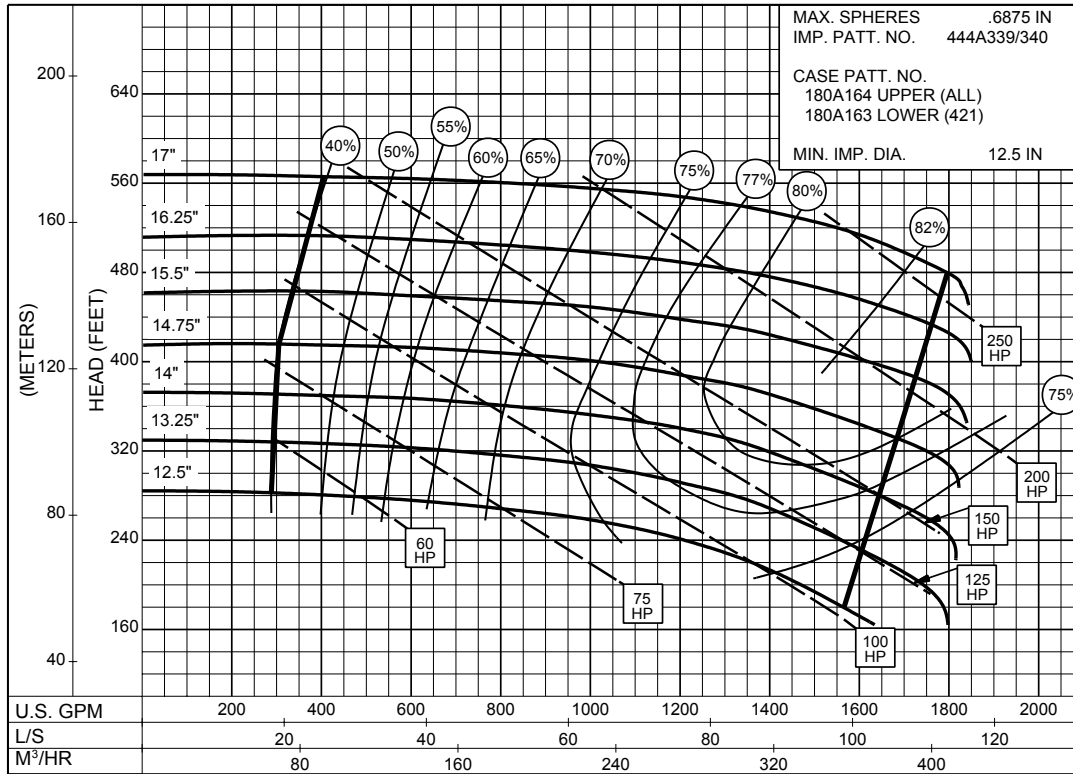

1750
R.P.M

1PC-115905

6 x 8 x 17B SERIES 420

ENCLOSED IMPELLER

SIZE : 6x8x17B TYPE : 420 IMPELLER : Enclosed R. P. M. : 1750

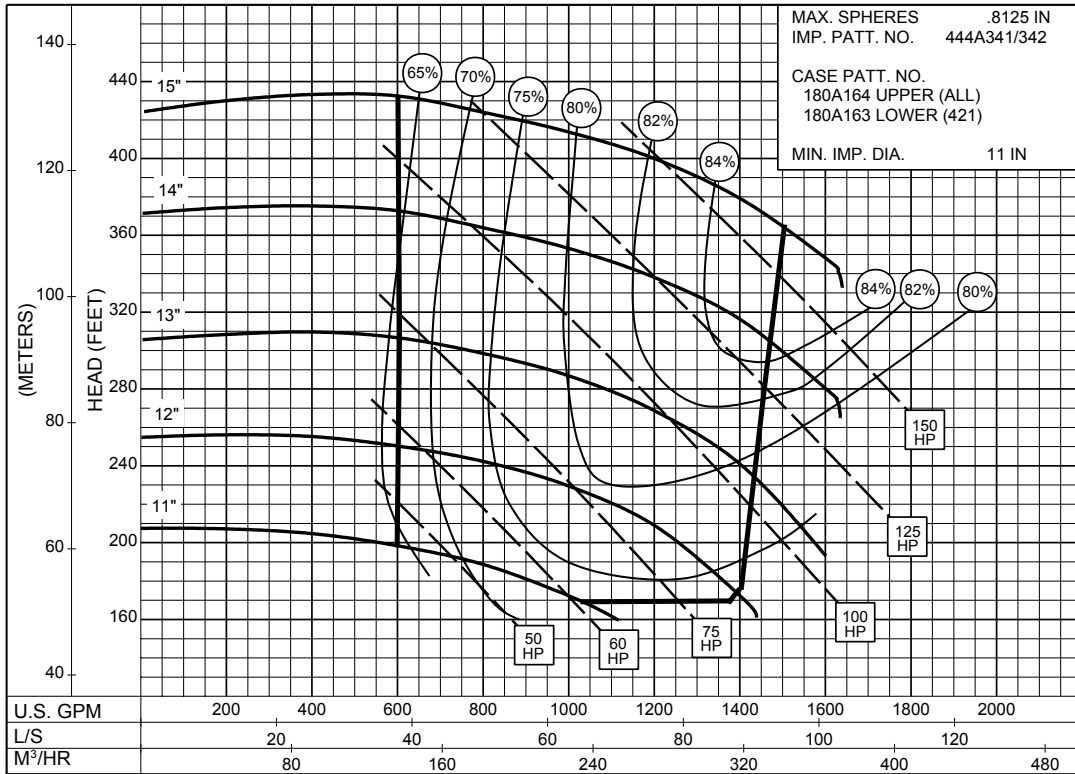

IPC-115906

1750
R.P.M

SIZE : 6x8x17B TYPE : 420 IMPELLER : Enclosed R. P. M. : 1150

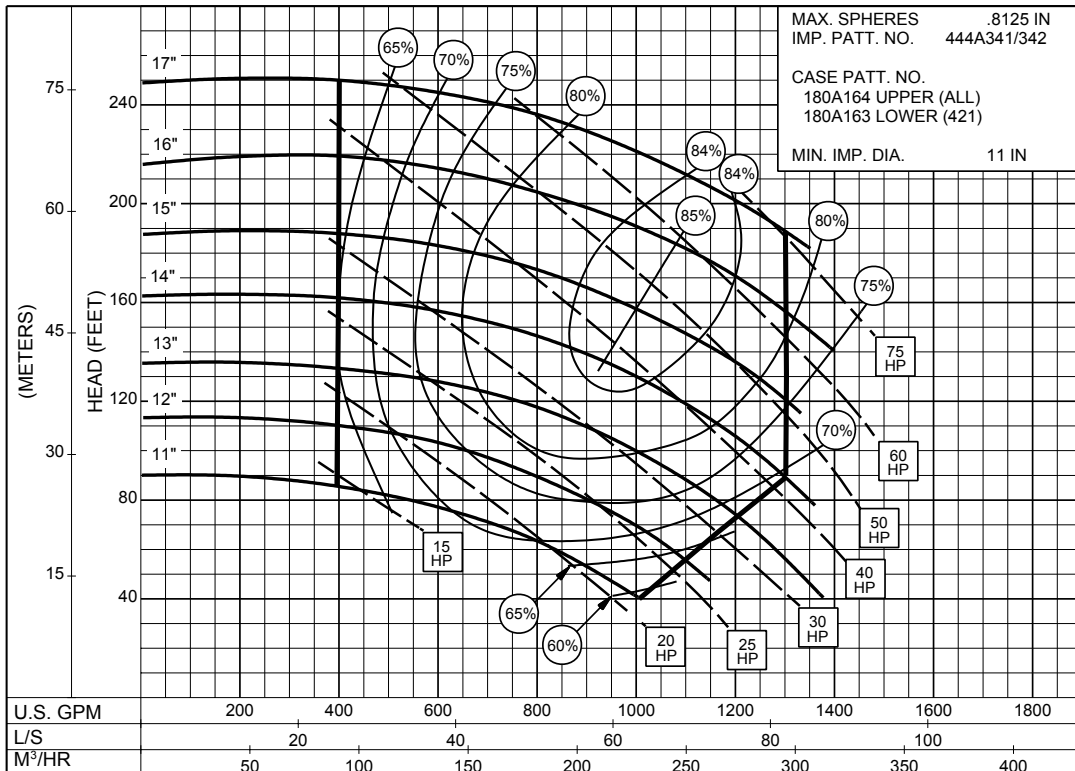

IPC-115907

1150
R.P.M